

FEATURES:

- Universal Input 90~264VAC
- Efficiency at 88% Typical
- Protection: Short Circuit /Over load/ Over Voltage

Specifications typical at TA=25°C, nominal input voltage and rated output current unless otherwise specified

Part Number	Output Wattage	Output Voltage	Output Current		Ripple & Noise(note)	Efficiency
	(W)	(V)	(mA)(min)	(mA)(max)	(mV) max	%(TYP)
GP25D-S48C01	27	Vo=+48.0	0	560	240	88

Input Specifications

Parameters	Conditions	Min	Typ	Max	Units
Rated input voltage	Vo,lo nom		100-240		Vac
Voltage Range	Vo,lo nom	AC in	90	264	Vac
		DC in	120	370	Vdc
Frequency		47	50/60	63	Hz
Input Current	Vo,lo nom			0.7	A

Output Specifications

Parameters	Conditions	Min	Typ	Max	Units
Output Voltage Accuracy	Vi nom,lo nom	Vo		±2	%
Minimum Load	Vi nom	0			
Line Regulation	lo nom,Vi min...Vi max		±0.2		%
Load Regulation	Vi nom, lo min...lo nom	Vo	±0.5		%
Transient Recovery time	Vi nom,lo nom = ↔0.5 lo nom		1,000		uS
Protection	Over load	Above 110% rated output power			
		Protection type: Recovers automatically after fault condition is removed			
	Short circuit	Recovers automatically after fault condition is removed			
	Over Voltage	120%-150% rated output Voltage			
Protection type: Zener diode clamp					

Note . Ripple & noise is measured by using 20 MHz bandwidth, measured with a 47uf paralleled with a high-frequency 0.47uf capacitor across each output by full load.

General Specifications					
Parameters	Conditions	Min	Typ	Max	Units
Switching Frequency	Vi nom,lo nom		65		KHz
Isolation Voltage	Input / Output	3KVac/ 5mA/5Secs			
Isolation Resistance	Input / Output,@500 Vdc	100			MΩ
Operating Temperature	Operating at Vi nom,lo nom	-20		+70	°C
Storage Temperature	Non Operational	-40		+105	°C
Relative Humidity@40°C	Vi nom,lo nom			95	% RH
Safety Standards	Design refer to UL62368-1,IEC62368-1				
EMI Conduction & Radiation	EN55032,CLASS B(See Fig. 1 for recommended circuit)				
EMS Immunity	EN61000 (See Fig. 1 for recommended circuit)				
Dimension	L66.5 x W47.5 x H22 mm				
Cooling	Free air convection				

Temperature Derating Graph

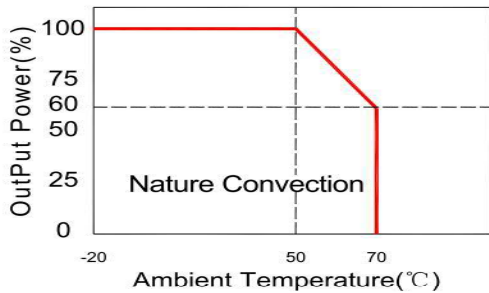

Parallel Lines Measure

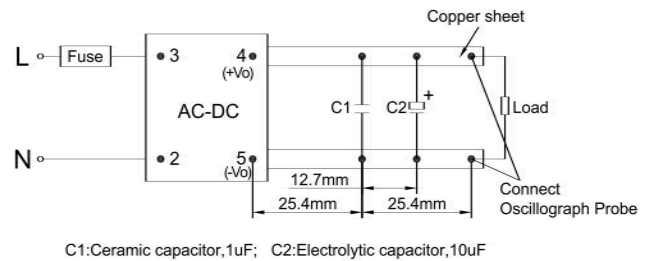

EMC solution-recommended circuit

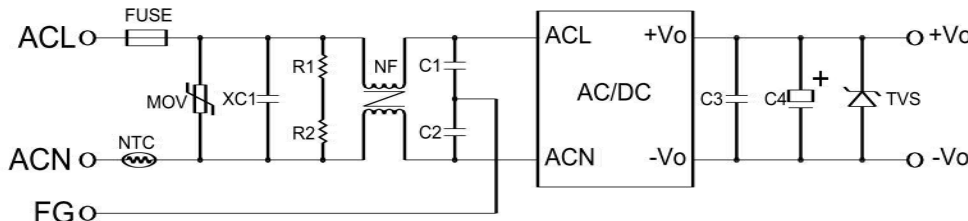

NOTE:
 MOV: 10D471K
 XC1: 0.22uF/275V, X2
 R1/R2: 750K, 1206
 NF: UU9.8, 30mH
 C1/C2: 470pF/250V, Y2
 NTC: MOSP005M-5
 FUSE: 3.15A/250V

Fig. 1

Markings and dimensions

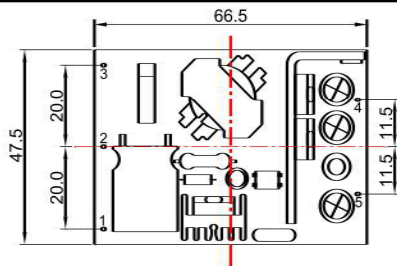

PIN	Model
1	NC
2	ACN
3	ACL
4	+Vo
5	-Vo

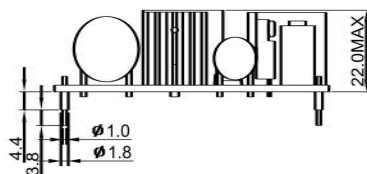

UNIT: mm Unless otherwise specified, all tolerances are ± 0.50

1. Weight:51.2grams/pcs
2. outer carton unit : 72pcs/box
3. Weight: 4.8kg per carton

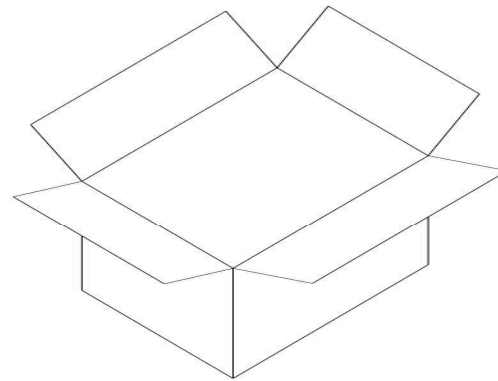
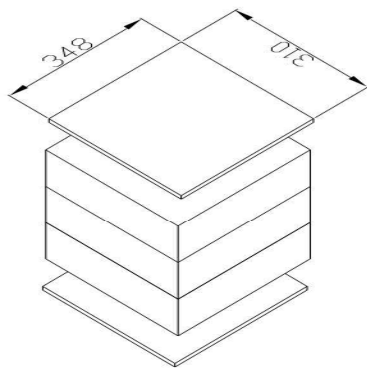
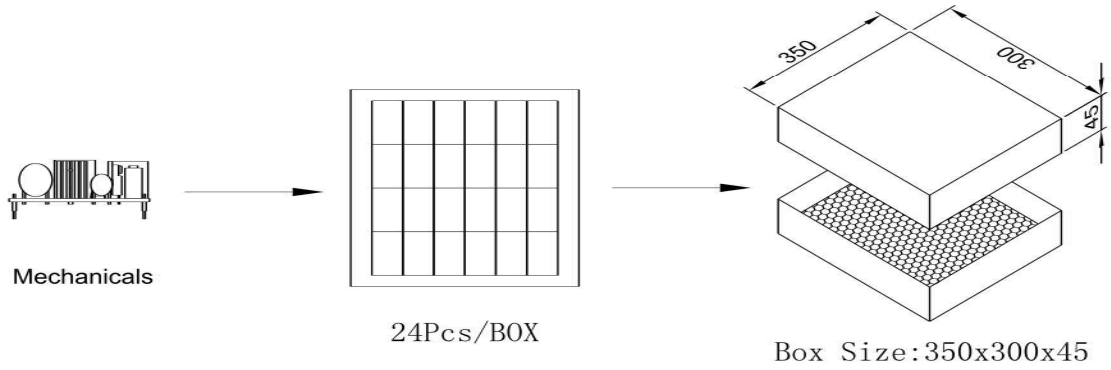

Outer carton: 375x320x160mm

UNIT:mm