

Features

- 3PIN SIP Package
- Pin-out compatible with LM78XX Linears
- Operating Temperature:-40°C TO +85°C
- Efficiency up to 87%
- Non isolated,no need for heatsinks
- Short circuit protection, Thermal shutdown



**NON-ISOLATED
DC/DC Converter**

Input Specifications

Input Voltage	:48Vdc	
Input Voltage Range	:9~90Vdc	
Input current	:2mA MAX	@Vin=48V , No Load

Output Specifications

Output Voltage	:5Vdc	
Output Voltage Accuracy	:±3% MAX	@Vout=4.85~5.15Vdc @Vin=9~90Vdc
Output Current	:500mA	
Efficiency	:87% TYP	@Min Vin
	:75% TYP	@Max Vin
Ripple / Noise	:80mVp-p MAX	@20MHz Bandwidth
Short Circuit Protection	:Continuous	@automatics recovery
Line Regulation	:±1.5% MAX	@LL to HL at Full Load
Load Regulation	:±2.0% MAX	@10% to 100% load

General Specifications

Operating Temperature Range	:-40°C ~ +85°C (with derating)	
Storage Temperature	:-55°C ~ +125°C	
Switching Frequency	:300KHz	
Humidity	:95% MAX	
Cooling	:Free air convection	
MTBF	:>2000000 Hours	MIL-HDBK-217F@25°C,Ground Benign.
Weight	:4.0g TYP	
Conducted Emission	:EN55022 Class A	
Radiated Emission	:EN55022 Class A	

Temperature Derating Graph

Part Number

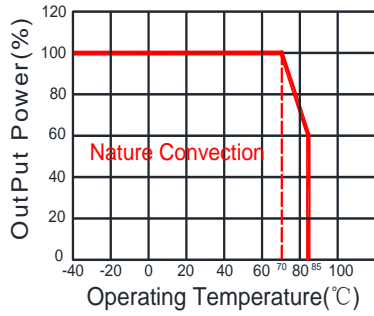

08DC — 05 — 500

A B C

A: Series

B: Output Voltage

C: Output Current

Outline Dimensions

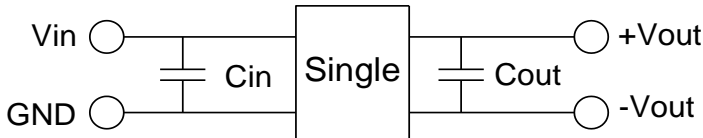

Vin	Cin	Single Vout	Cout
48Vdc	10μF/100V	5Vdc	22μF/10V

To make sure the product work at perfect operation status with full loading external capacitor is necessary and it is recommended to use high frequency low resistance electrolytic capacitor

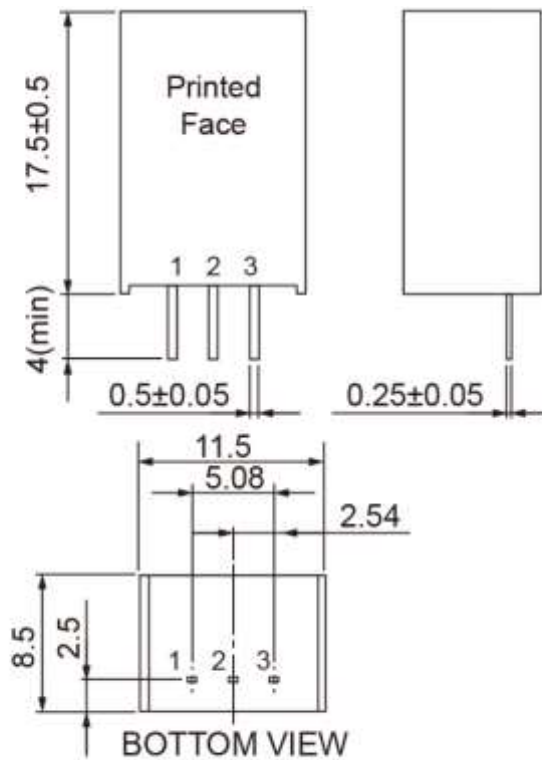

Unit : mm Tolerance : XX.X±0.5 , XX.XX±0.25

PIN Assignment

PIN	1	2	3
FUNCTION	+Vin	GND	+Vout

Packing Formation

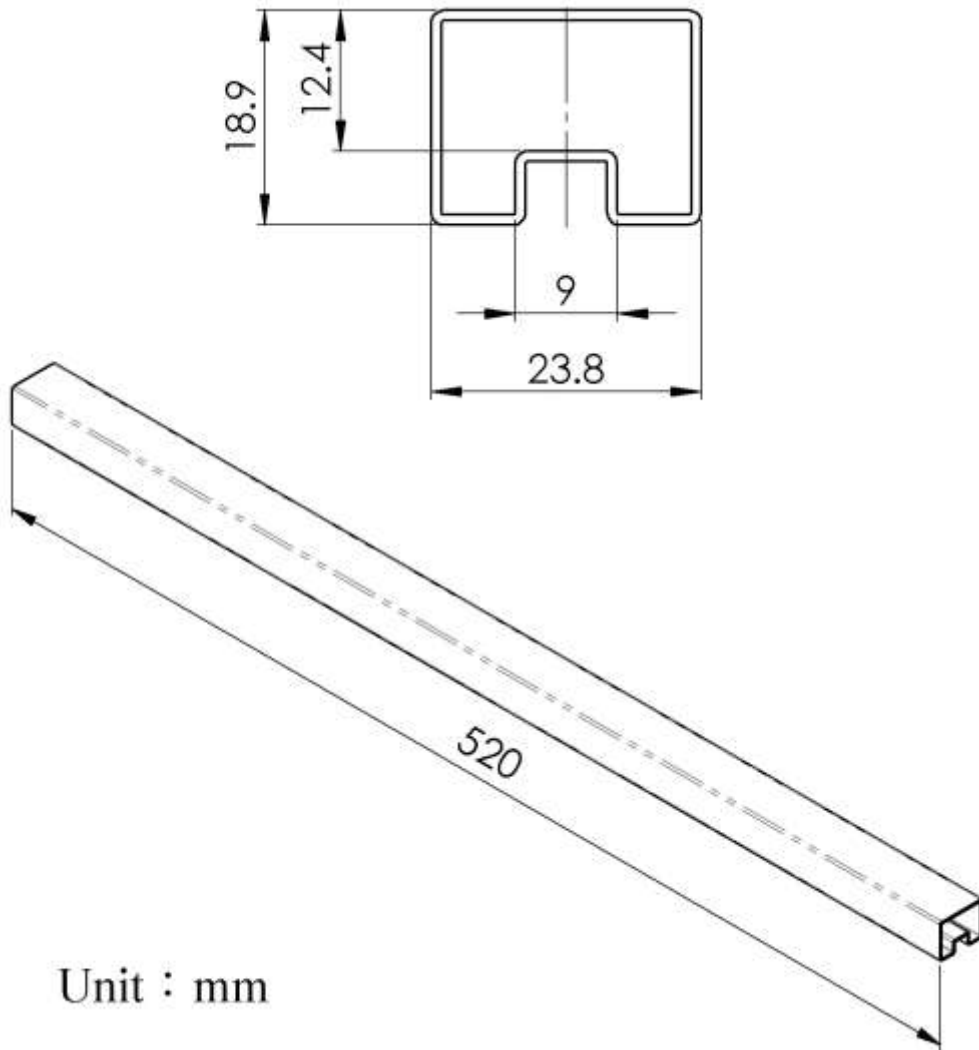

Unit : mm

Weight	: 4.0 grams/pcs
TUBE	: 42 pcs