

Features

- 1WATT SIP PACKAGE
- EFFICIENCY TO 82%
- 100% BURNED IN
- No-load Input Current as Low as 5mA
- UL 94V-0 PACKAGE MATERIAL
- CUSTOM SOLUTIONS AVAILABLE
- UNREGULATED OUTPUT TYPES



**1 Watt DC/DC
Converter**

1 Watt Single O/P
Isolated DC-DC Converter  [®] US

Input Specifications

Input Voltage	:5Vdc
Input Voltage Range	:±10%

Output Specifications

Output Voltage	:5Vdc	
Output Voltage Accuracy	:±5%	@Vout=4.75~5.25Vdc@Vin=5Vdc
Output Current	:200mA	
Efficiency	:82% TYP	
Ripple / Noise	:30mVp-p TYP, 75mVp-p MAX	@20MHz Bandwidth
Short Circuit Protection	: Continuous	
Line Regulation	:±1.2% TYP	@For 1.0% OF Vin
Load Regulation	:±10% TYP, ±15% MAX	@10% to 100% full load
Capacitive Load	:2400uF MAX	

General Specifications

Operating Temperature Range	: -40°C ~ +105°C	
Storage Temperature	: -55°C ~ +125°C	
Switching Frequency	: 370KHz TYP	
Humidity	: 95% MAX	
Isolation Voltage	: 1500Vdc	@ Input to Output (60sec/0.5mA)
Isolation Resistance	: 1000MΩ MIN	@ 500Vdc
Cooling	: Free air convection	
MTBF	: >3500000 Hours	MIL-HDBK-217F@25°C, Ground Benign.
Case Material	: DAP	
Weight	: 2.1g TYP	
EMI	CE	CISPR32/EN55032 CLASS B (see Fig. 1 for recommended circuit)
	RE	CISPR32/EN55032 CLASS B (see Fig. 1 for recommended circuit)
EMS	ESD	IEC/EN61000-4-2 Air ±8kV , Contact ±6kV perf. Criteria B

Temperature Derating Graph

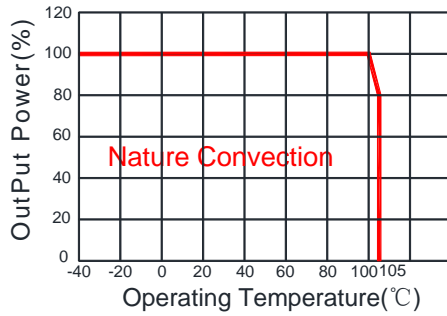

Part Number

12DC - 05 S 05 N P
A B C D E F

A:Series
B:Input Voltage
C:Single Output
D:Output Voltage
E:Unregulated(N)
F:Protection

Recommended Test Circuit

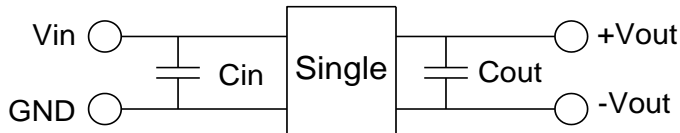

Vin	Cin	SingleVout	Cout
5Vdc	4.7μF/25V	5Vdc	10μF/16V

To make sure the product work at perfect operation status with full loading external capacitor is necessary and it is recommended to use high frequency low resistance electrolytic capacitor.

EMC (CLASS B) compliance circuit

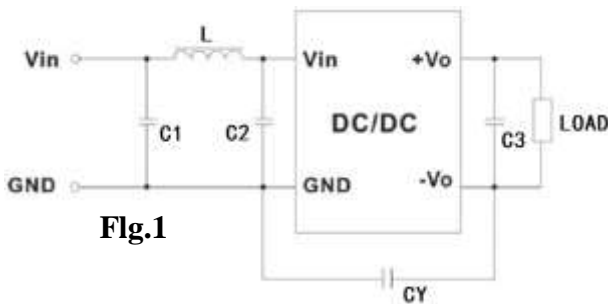

EMC recommended circuit value table		
EMI	C1	4.7μF /50V
	C2	4.7μF /50V
	CY	1nF/4kV
	C3	Recommended Test Circuit
	L	6.8μH

Outline Dimensions

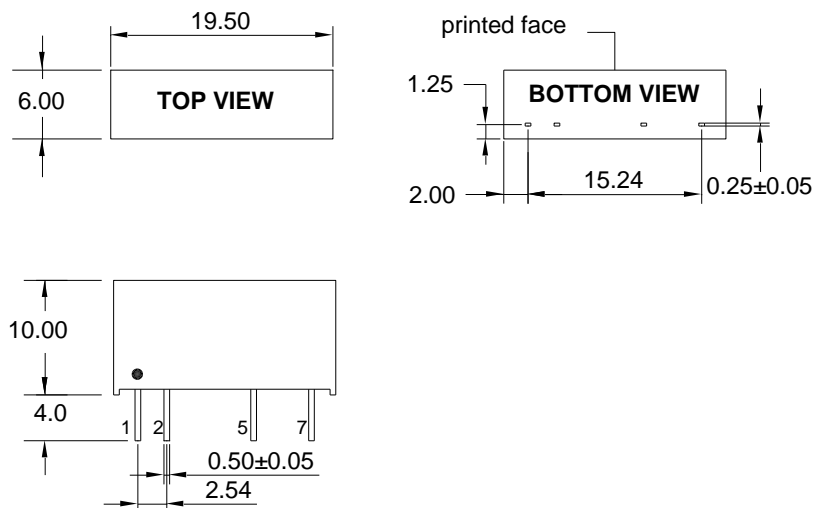

UNIT:mm Unless otherwise specified,all tolerances are ±0.25

PIN	1	2	5	7
Single	+Vin	-Vin	-Vout	+Vout

Packing Information:

Weight----- 2.1grams/pcs

TUBE-----25pcs

Weight: 73g per tube

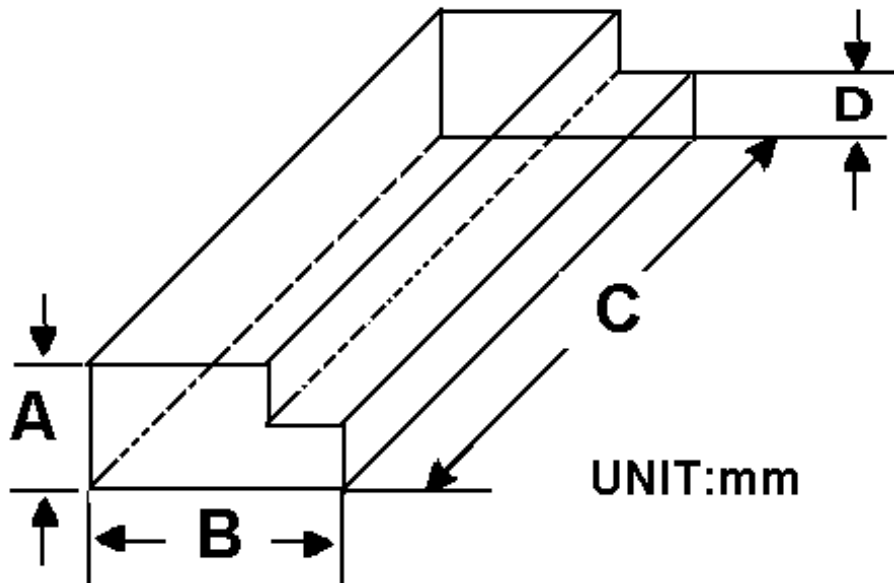

Size(mm)			
A	B	C	D
9.50	16.50	522	5.00

Outer carton unit: 2500pcs/100Tube/box

Weight: 7.5kg per carton

