

## Features

- 1WATT SIP PACKAGE
- EFFICIENCY TO 87%
- 100% BURNED IN
- No-load Input Current as Low as 5mA
- UL 94V-0 PACKAGE MATERIAL
- CUSTOM SOLUTIONS AVAILABLE
- UNREGULATED OUTPUT TYPES



**1 Watt DC/DC Converter**

1 Watt Dual O/P  
Isolated DC-DC Converter  <sup>®</sup> US

## Input Specifications

Input Voltage	:24Vdc
Input Voltage Range	:±20%

## Output Specifications

Output Voltage	:±15Vdc	
Output Voltage Accuracy	:±5%	@Vout=±14.25~±15.75Vdc@Vin=24Vdc
Output Current	:±34mA	
Efficiency	:87% TYP	
Ripple / Noise	:30mVp-p TYP, 75mVp-p MAX	@20MHz Bandwidth
Short Circuit Protection	: Continuous	
Line Regulation	:±1.2% TYP	@For 1.0% OF Vin
Load Regulation	:±6% TYP, ±10% MAX	@10% to 100% full load
Capacitive Load	:±220uF MAX	

## General Specifications

Operating Temperature Range	: -40°C ~ +105°C	
Storage Temperature	: -55°C ~ +125°C	
Switching Frequency	: 250KHz TYP	
Humidity	: 95% MAX	
Isolation Voltage	: 3000Vdc	@ Input to Output ( 60sec/0.5mA )
Isolation Resistance	: 1000MΩ MIN	@ 500Vdc
Cooling	: Free air convection	
MTBF	: >3500000 Hours	MIL-HDBK-217F@25°C, Ground Benign.
Case Material	: DAP	
Weight	: 2.1g TYP	
EMI	CE	CISPR32/EN55032 CLASS B (see Fig. 1 for recommended circuit)
	RE	CISPR32/EN55032 CLASS B (see Fig. 1 for recommended circuit)
EMS	ESD	IEC/EN61000-4-2 Air ±8kV , Contact ±4kV perf. Criteria B

## Temperature Derating Graph

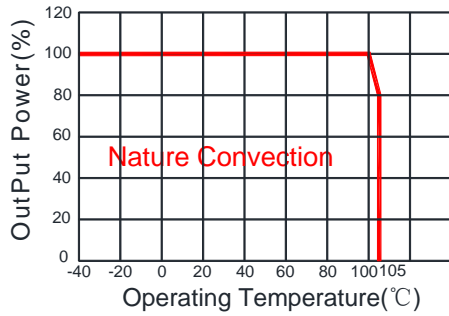

## Part Number

12DC - 24 D 15 N P H3

A B C D E F G

A:Series

B:Input Voltage

C:Dual Output

D:Output Voltage

E:Unregulated(N)

F:Protection

G:Isolation Voltage

## Recommended Test Circuit

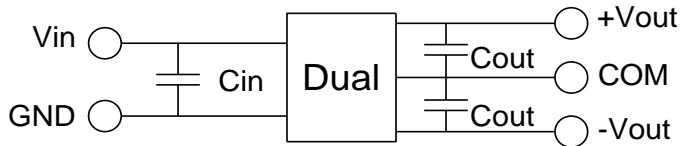

Vin	Cin	Dual Vout	Cout
24Vdc	1μF/50V	±15Vdc	±1μF/25V

To make sure the product work at perfect operation status with full loading external capacitor is necessary and it is recommended to use high frequency low resistance electrolytic capacitor.

## EMC (CLASS B) compliance circuit

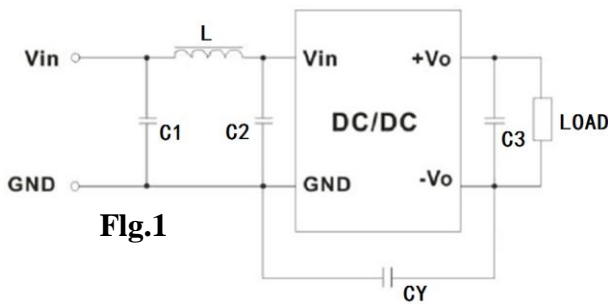

EMC recommended circuit value table		
EMI	C1	4.7μF /50V
	C2	4.7μF /50V
	CY	1nF/4kV
	C3	Recommended Test Circuit
	L	6.8μH

## Outline Dimensions

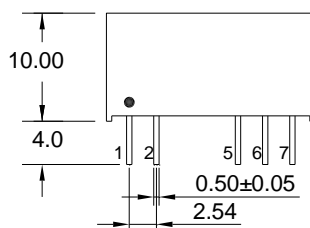
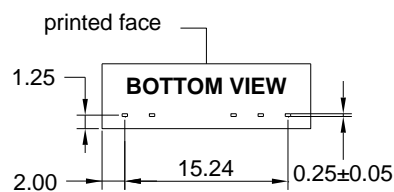
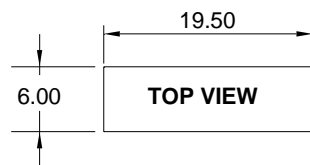

**UNIT:mm Unless otherwise specified,all tolerances are ±0.25**

PIN	1	2	5	6	7
DUAL	+Vin	-Vin	-Vout	COM	+Vout

**Packing Information:**

Weight----- 2.1grams/pcs

TUBE-----25pcs

Weight: 73g per tube



Size(mm)			
A	B	C	D
9.50	16.50	522	5.00

Outer carton unit: 2500pcs/100Tube/box

Weight: 7.5kg per carton

