

**Features**

- 10PIN SMD Package
- UL94V-0 Package Material
- Operating Temperature:-40°C TO +85°C
- Efficiency up to 93%
- Non isolated, no need for heatsinks
- Short circuit protection



**NON-ISOLATED  
DC/DC Converter**

**Input Specifications**

Input Voltage Range	:12~36Vdc
Input current no load	:3mA TYP
Input Filter	: Capacitor
Remote ON	: 3.2 ~ 5.5VDC or open circuit
Remote OFF	: 0 ~ 0.8VDC or short circuit pin 10 and 3/7
OFF Idle Current	: 0.2mA typ.

**Output Specifications**

Output Voltage	:9Vdc	
Output Voltage Accuracy	:±3%	@Vout=8.73~9.27Vdc @Vin=12~36Vdc
Output Voltage Adjustability (Trim)	:±10% max.	
Output Current	:1000mA	
Efficiency	:93% TYP @Min Vin	
	:90% TYP @Max Vin	
Ripple / Noise	:75mVp-p MAX	@20MHz Bandwidth
Short Circuit Protection	:Continuous	@auto-recovery
Line Regulation	:±0.4% MAX	@ at Full Load
Load Regulation	:±0.6% MAX	@10% to 100% load
Capacitive load	:680uF MAX	

**General Specifications**

Operating Temperature Range	:-40°C ~ +85°C (with derating)		
Storage Temperature	:-55°C ~ +125°C		
Switching Frequency	:440KHz TYP		
Humidity	:95% MAX		
Cooling	:Free air convection	@(20 LFM)	
MTBF	:>5000x10 <sup>3</sup> Hours	MIL-HDBK-217F@25°C,Ground Benign.	
Weight	:1.8g TYP		
EMI	CE	CISPR32/EN55032 CLASS B (see Fig. 2 for recommended circuit)	
	RE	CISPR32/EN55032 CLASS B (see Fig. 2 for recommended circuit)	
	ESD	IEC/EN61000-4-2 Contact ±4kV perf.	Criteria B
	radiated immunity	IEC/EN61000-4-3, 10V/m	Criteria A
EMS	EFT/burst	IEC/EN61000-4-4, ± 1kV (see Fig. 2 for recommended circuit)	Criteria B
	surge	IEC/EN61000-4-5, line-line ± 1kV (see Fig. 2 for recommended circuit)	Criteria B
	conducted immunity	IEC/EN61000-4-6, 3 Vr.m.s	Criteria A

Temperature Derating Graph

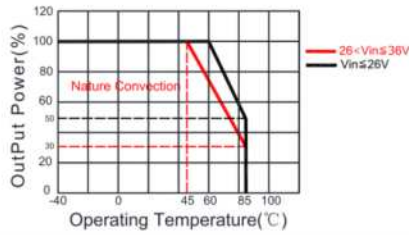

Part Number

13DS - 09 - 1A

A B C

A:Series

B:Output Voltage

C:Output Current

Application of Vadj and calculation of Vadj resistance

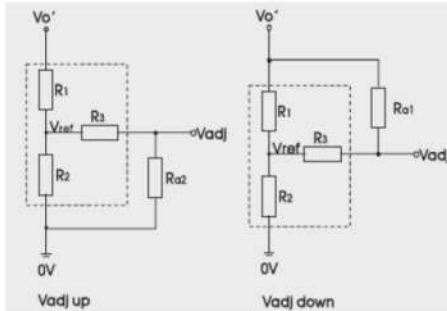

Calculation formula of Vadj resistance:

$$\text{up: } R_{a2} = \frac{aR_2}{R_2 - a} - R_3 \quad a = \frac{V_{ref}}{V_o' - V_{ref}} \cdot R_1$$

$$\text{down: } R_{a1} = \frac{aR_1}{R_1 - a} - R_3 \quad a = \frac{V_o' - V_{ref}}{V_{ref}} \cdot R_2$$

Ra1, Ra2 is Vadj resistance, a is a self-defined parameter, with no real meaning. Vo' for the actual needs of the up or down regulated voltage

R1/KΩ	R2/KΩ	R3/KΩ	Vref/V
82	8.06	33	0.8

Typical Application Circuit

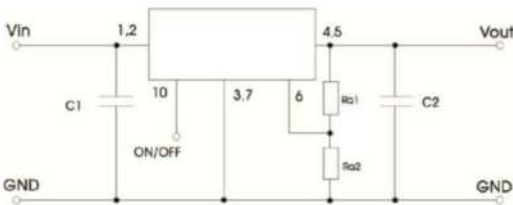
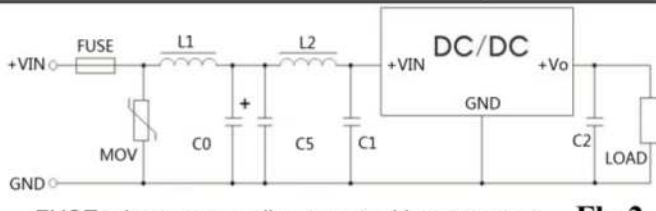

Fig.1

Vin	C1	Single Vout	C2
24Vdc	10μF/50V	9Vdc	22μF/16V

- C1 and C2 are required and should be connected close to the pin terminal of the module.
- For capacitance of C1 and C2 refer to table, it can be increased properly if required, and tantalum or low ESR electrolytic capacitors may also suffice.
- Cannot be used in parallel for output and hot swap.

EMC (CLASS B) compliance circuit



FUSE: choose according to actual input current

Fig.2

Component	Value	Component	Value
MOV	S20K30	C0	680μF/50V
L1	82μH	C1,C2	refer to Fig.1
L2	68μH	C5	4.7μF/50V

Outline Dimensions

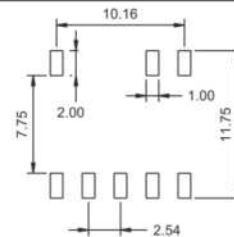
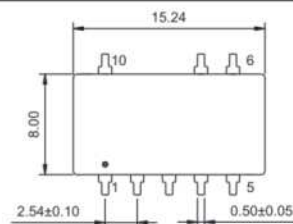

SUGGESTED PAD LAYOUT

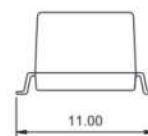
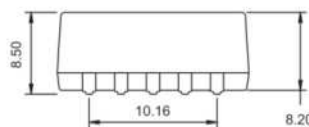

PIN Assignment

PIN	1.2	3.7	4.5	6	10
FUNCTION	+Vin	GND	+Vout	V adj	Remote On/Off

## RoHS compliant type

Our RoHS parts just can withstand IR Reflow peak temperature: 240degC +/-5degC as the following profile:

Profile Feature	Pb-Free Assembly
Average Ramp-Up Rate ( $T_{s\ max}$ to $T_p$ )	3 <sup>0</sup> C /second max.
<b>Preheat</b> -Temperature Min ( $T_{s\ min}$ ) -Temperature Max ( $T_{s\ max}$ ) -Time ( $t_{s\ min}$ to $t_{s\ max}$ )	150 <sup>0</sup> C 200 <sup>0</sup> C 60-180 seconds
<b>Time maintained above:</b> -Temperature ( $T_L$ ) -Time ( $t_L$ )	217 <sup>0</sup> C 60-150 seconds
Peak/Classification Temperature ( $T_p$ )	240±5 <sup>0</sup> C
Time within 5 <sup>0</sup> C of actual Peak Temperature ( $t_p$ )	20-40 seconds
Ramp-Down Rate	6 <sup>0</sup> C/seconds max
Time 25 <sup>0</sup> C to Peak Temperature	6 minutes max.

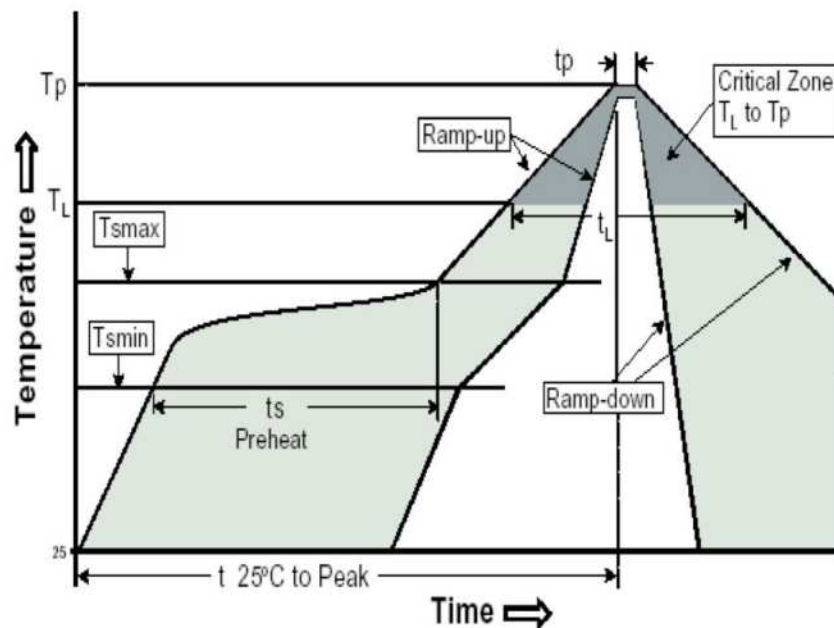

**Packing Information:**

- 1. Weight-----1.8 grams/pcs
- 2. Tape & Reel----- 500 pcs
- 3. outer carton unit: 4000pcs/box
- 4. outer carton unit: 8T&R/box
- 5. Weight: 12.2kg per carton

