

**Features**

- 1WATT SMD PACKAGE
- EFFICIENCY TO 84%
- 100% BURNED IN
- UL 94V-0 PACKAGE MATERIAL
- CUSTOM SOLUTIONS AVAILABLE
- UNREGULATED OUTPUT TYPES



**1 Watt DC/DC Converter**

**1 Watt Dual O/P Isolated DC-DC Converter**

**Input Specifications**

Input Voltage	:5Vdc
Input Voltage Range	:±10%

**Output Specifications**

Output Voltage	:±12Vdc	
Output Voltage Accuracy	:±5%	@Vout=±11.4~±12.6Vdc@Vin=5Vdc
Output Current	:±42mA	
Efficiency	:84% TYP	
Ripple / Noise	:30mVp-p TYP, 75mVp-p MAX	@20MHz Bandwidth
Short Circuit Protection	: Continuous	
Line Regulation	:±1.2% TYP	@ For 1.0% OF Vin
Load Regulation	:±10% MAX	@10% to 100% full load
Capacitive Load	:±220uF MAX	

**General Specifications**

Operating Temperature Range	: -40°C ~ +105°C	
Storage Temperature	: -55°C ~ +125°C	
Switching Frequency	: 370KHz TYP	
Humidity	: 95% MAX	
Isolation Voltage	: 1500Vdc	@ Input to Output (60sec/0.5mA )
Isolation Resistance	: 1000MΩ MIN	@ 500Vdc
Cooling	: Free air convection	
MTBF	: >3500000 Hours	MIL-HDBK-217F@25°C, Ground Benign.
Case Material	: DAP	
Weight	: 1.36g TYP	
EMI	CE	CISPR32/EN55032 CLASS B (see Fig. 1 for recommended circuit)
	RE	CISPR32/EN55032 CLASS B (see Fig. 1 for recommended circuit)
EMS	ESD	IEC/EN61000-4-2 Air ±8kV , Contact ±6kV perf. Criteria B

## Temperature Derating Graph

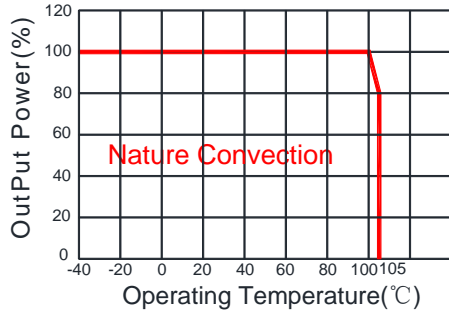

## Part Number

13DS1C - 05 D 12 N 3 P

A B C D E F G

A:Series  
 B:Input Voltage  
 C:Duao Output  
 D:Output Voltage  
 E:Unregulated(N)  
 F:Package  
 G:Protection

## Recommended Test Circuit

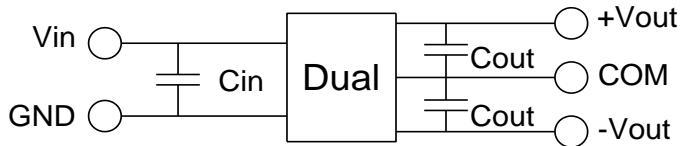

Vin	Cin	Dual Vout	Cout
5Vdc	4.7μF/25V	±12Vdc	±1μF/25V

To make sure the product work at perfect operation status with full loading external capacitor is necessary and it is recommended to use high frequency low resistance electrolytic capacitor.

## EMC (CLASS B) compliance circuit

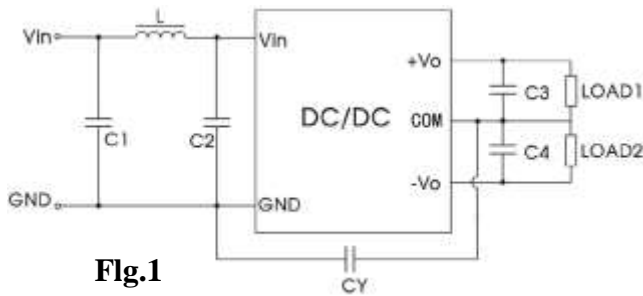
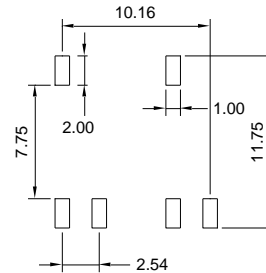
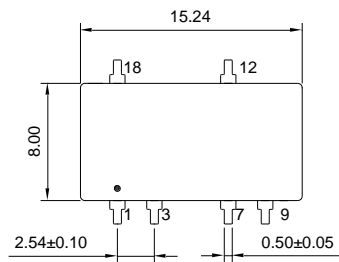

Fig.1

EMC recommended circuit value table		
EMI	C1	4.7μF /50V
	C2	4.7μF /50V
	CY	1nF/4kV
	C3,C4	Recommended Test Circuit
	L	6.8μH

## Outline Dimensions



SUGGESTED PAD LAYOUT

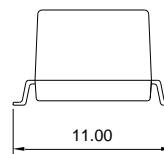
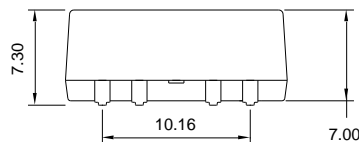

UNIT:mm Unless otherwise specified,all tolerances are ±0.25

<b>PIN</b>	1	3	7	9	12	18
<b>DUAL</b>	-Vin	+Vin	COM	-Vout	+Vout	NC

## RoHS compliant type

Our RoHS parts just can withstand IR Reflow peak temperature: 240degC +/-5degC as the following profile:

Profile Feature	Pb-Free Assembly
Average Ramp-Up Rate ( $T_{s\ max}$ to $T_p$ )	3 <sup>0</sup> C /second max.
<b>Preheat</b> -Temperature Min ( $T_{s\ min}$ ) -Temperature Max ( $T_{s\ max}$ ) -Time ( $t_{s\ min}$ to $t_{s\ max}$ )	150 <sup>0</sup> C 200 <sup>0</sup> C 60-180 seconds
<b>Time maintained above:</b> -Temperature ( $T_L$ ) -Time ( $t_L$ )	217 <sup>0</sup> C 60-150 seconds
Peak/Classification Temperature ( $T_p$ )	240±5 <sup>0</sup> C
Time within 5 <sup>0</sup> C of actual Peak Temperature ( $t_p$ )	20-40 seconds
Ramp-Down Rate	6 <sup>0</sup> C/seconds max
Time 25 <sup>0</sup> C to Peak Temperature	6 minutes max.

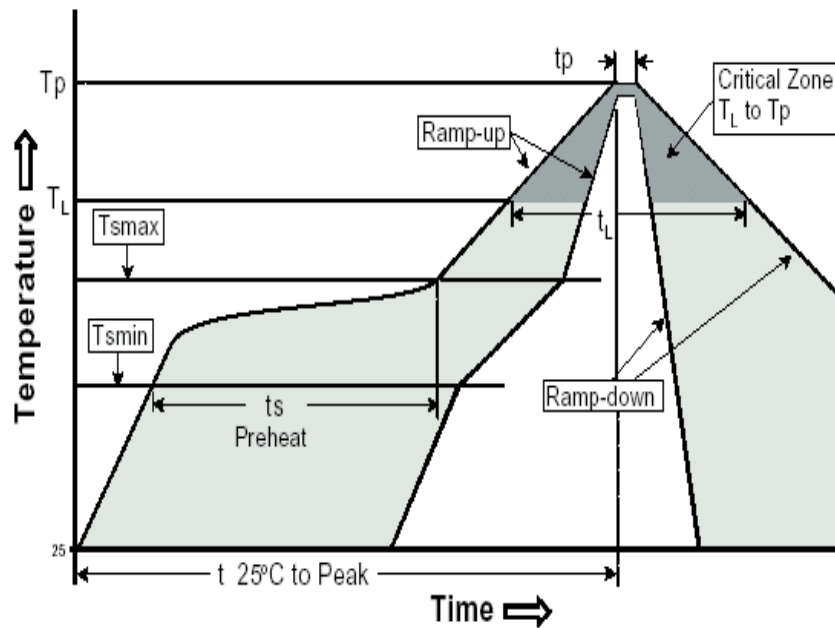

**Packing Information:**

- 1.Weight-----1.36 grams/pcs
- 2.Tape & Reel----- 350 pcs
- 3. outer carton unit: 2800pcs/box
- 4. outer carton unit: 8T&R/box
- 5.Weight:8.8kg per carton

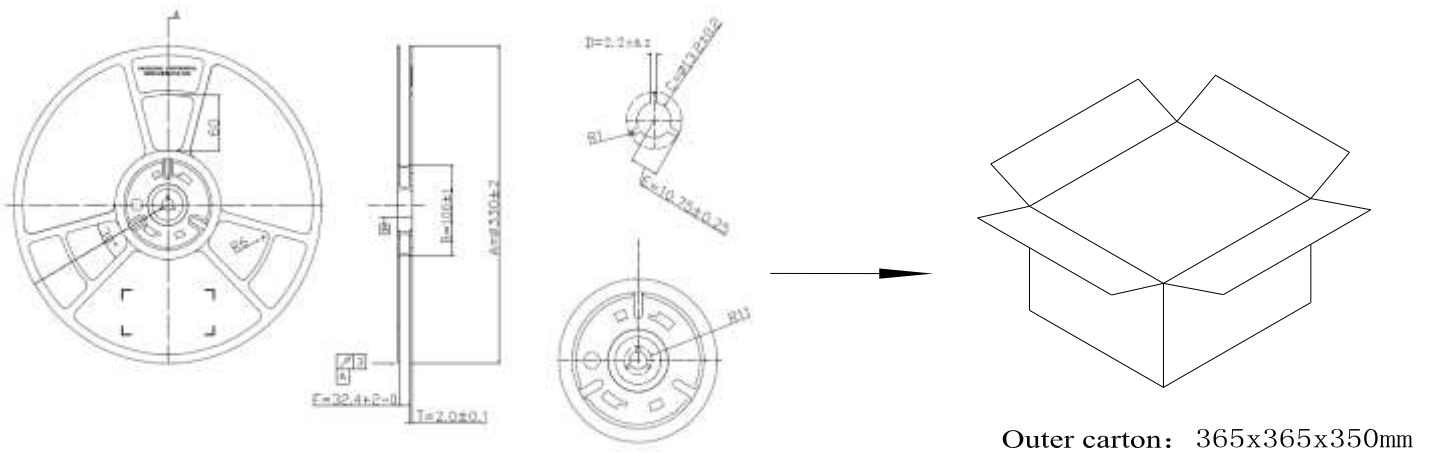
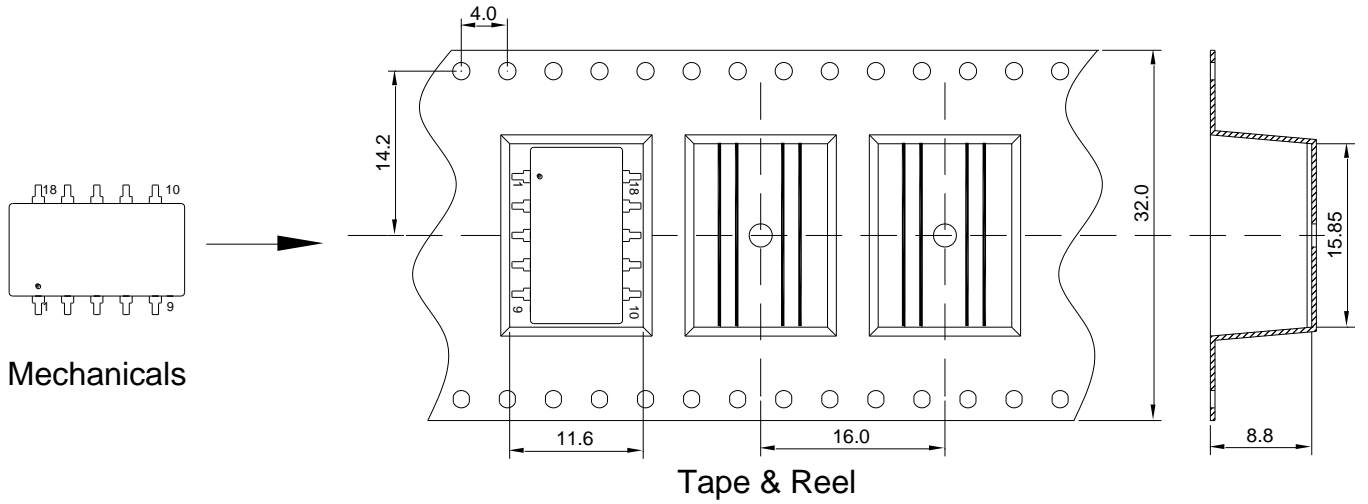

**Packing Information:**

Weight-----1.36grams/pcs

TUBE-----33pcs

Weight: 65g per tube

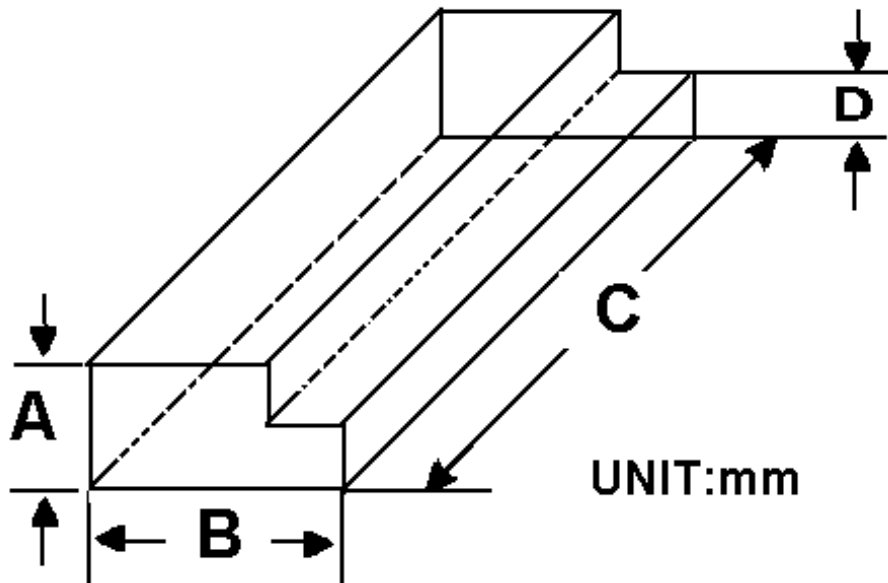

Size(mm)			
A	B	C	D
9.50	16.50	522	5.00

Outer carton unit: 3300pcs/100Tube/box

Weight: 7.5kg per carton

