

Features

- 1WATT SMD PACKAGE
- EFFICIENCY TO 85%
- 100% BURNED IN
- No-load Input Current as Low as 5mA
- UL 94V-0 PACKAGE MATERIAL
- CUSTOM SOLUTIONS AVAILABLE
- UNREGULATED OUTPUT TYPES



**1 Watt DC/DC
Converter**

**1 Watt Dual O/P
Isolated DC-DC Converter**

Input Specifications

Input Voltage	:15Vdc
Input Voltage Range	:±20%

Output Specifications

Output Voltage	:±12Vdc	
Output Voltage Accuracy	:±5%	@Vout=±11.4~±12.6Vdc@Vin=15Vdc
Output Current	:±42mA	
Efficiency	:85% TYP	
Ripple / Noise	:30mVp-p TYP, 75mVp-p MAX	@20MHz Bandwidth
Short Circuit Protection	: Continuous	
Line Regulation	:±1.2% TYP	@ For 1.0% OF Vin
Load Regulation	:±10% MAX	@10% to 100% full load
Capacitive Load	:±680uF MAX	

General Specifications

Operating Temperature Range	: -40°C ~ +105°C	
Storage Temperature	: -55°C ~ +125°C	
Switching Frequency	: 250KHz TYP	
Humidity	: 95% MAX	
Isolation Voltage	: 1500Vdc	@ Input to Output (60sec/0.5mA)
Isolation Resistance	: 1000MΩ MIN	@ 500Vdc
Cooling	: Free air convection	
MTBF	: >3500000 Hours	MIL-HDBK-217F@25°C, Ground Benign.
Case Material	: DAP	
Weight	: 1.36g TYP	
EMI	CE	CISPR32/EN55032 CLASS B (see Fig. 1 for recommended circuit)
	RE	CISPR32/EN55032 CLASS B (see Fig. 1 for recommended circuit)
EMS	ESD	IEC/EN61000-4-2 Air ±8kV, Contact ±4kV perf. Criteria B

Temperature Derating Graph

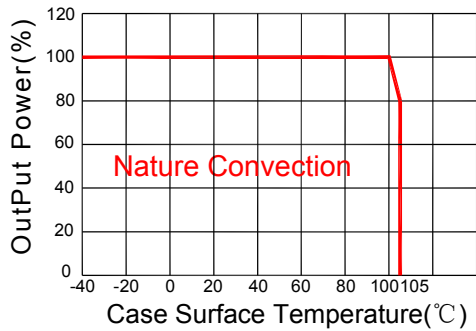

Part Number

13DS1C - 15 D 12 N 2 P
A B C D E F G

A:Series
B:Input Voltage
C:Dual Output
D:Output Voltage
E:Unregulated(N)
F:Package
G:Protection

Recommended Test Circuit

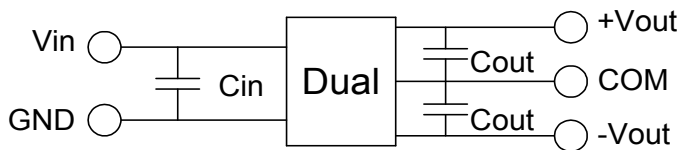

Vin	Cin	Dual Vout	Cout
15Vdc	2.2μF/25V	±12Vdc	±1μF/25V

To make sure the product work at perfect operation status with full loading external capacitor is necessary and it is recommended to use high frequency low resistance electrolytic capacitor.

EMC (CLASS B) compliance circuit

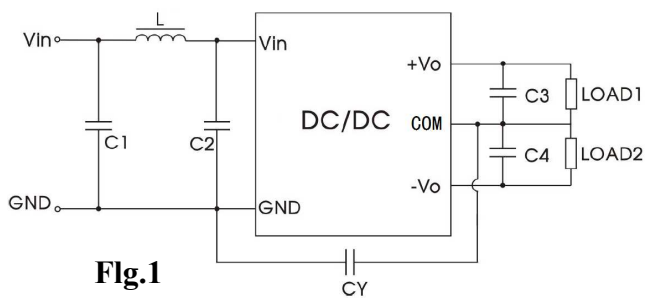
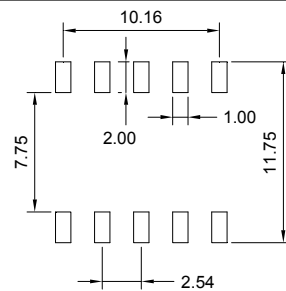
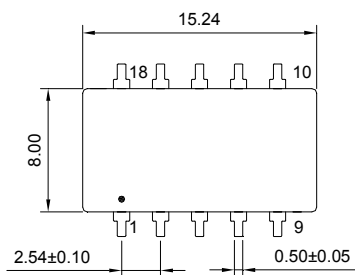

Fig.1

EMC recommended circuit value table		
EMI	C1	4.7μF /50V
	C2	4.7μF /50V
	CY	1nF/4kV
	C3,C4	Recommended Test Circuit
	L	6.8μH

Outline Dimensions



SUGGESTED PAD LAYOUT

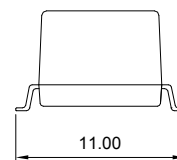
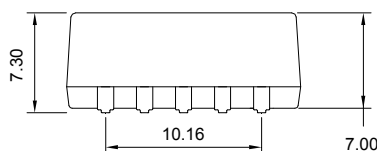

UNIT:mm Unless otherwise specified,all tolerances are ±0.25

PIN	1	3	7	9	12	OTHER
DUAL	-Vin	+Vin	COM	-Vout	+Vout	NC

RoHS compliant type

Our RoHS parts just can withstand IR Reflow peak temperature: 240degC +/-5degC as the following profile:

Profile Feature	Pb-Free Assembly
Average Ramp-Up Rate ($T_{s\ max}$ to T_p)	3 ⁰ C /second max.
Preheat -Temperature Min ($T_{s\ min}$) -Temperature Max ($T_{s\ max}$) -Time ($t_{s\ min}$ to $t_{s\ max}$)	150 ⁰ C 200 ⁰ C 60-180 seconds
Time maintained above: -Temperature (T_L) -Time (t_L)	217 ⁰ C 60-150 seconds
Peak/Classification Temperature (T_p)	240±5 ⁰ C
Time within 5 ⁰ C of actual Peak Temperature (t_p)	20-40 seconds
Ramp-Down Rate	6 ⁰ C/seconds max
Time 25 ⁰ C to Peak Temperature	6 minutes max.

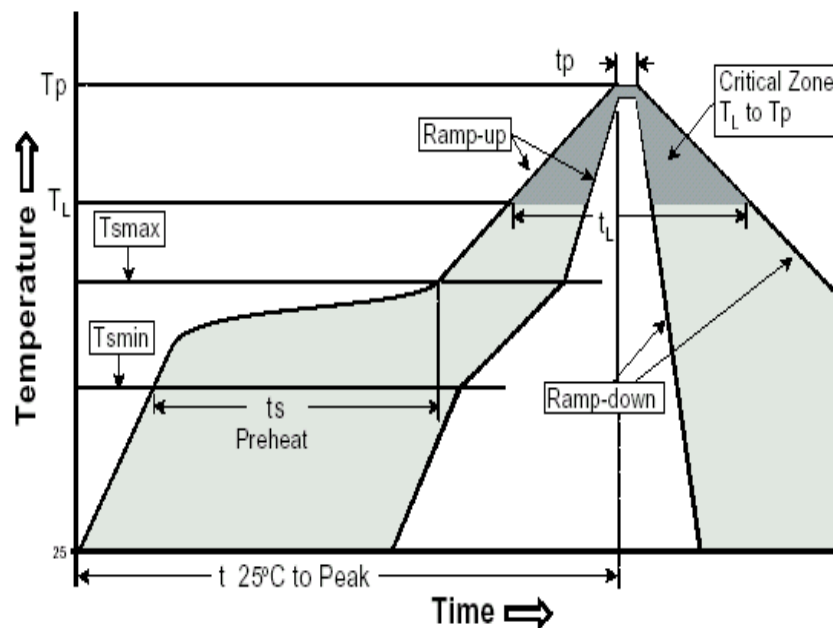

Packing Information:

1. Weight-----1.36 grams/pcs
2. Tape & Reel----- 350 pcs
3. outer carton unit: 2800pcs/box
4. outer carton unit: 8T&R/box
5. Weight:8.8kg per carton

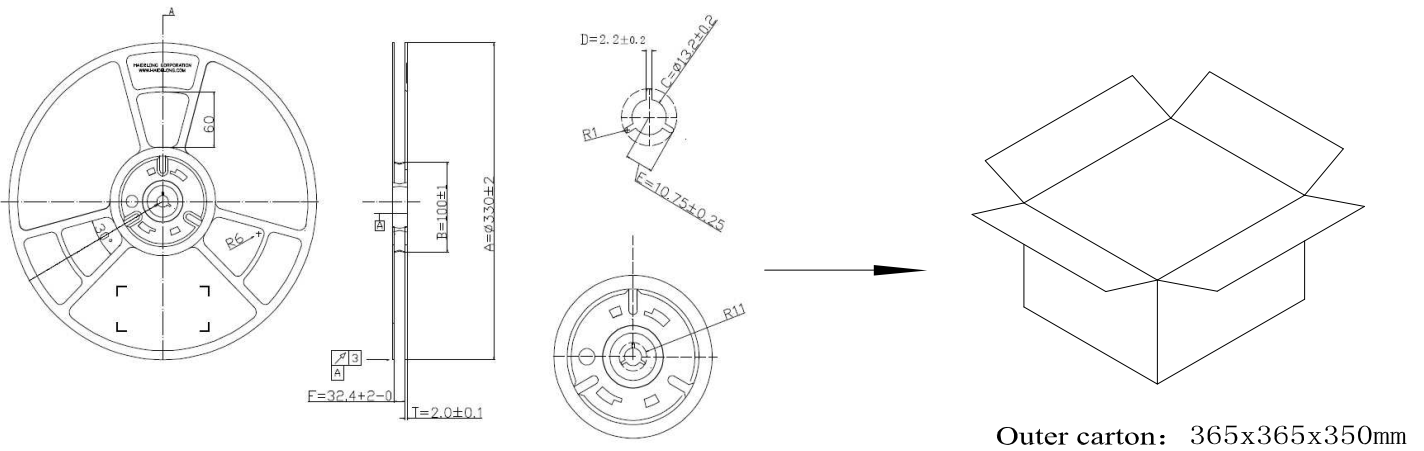
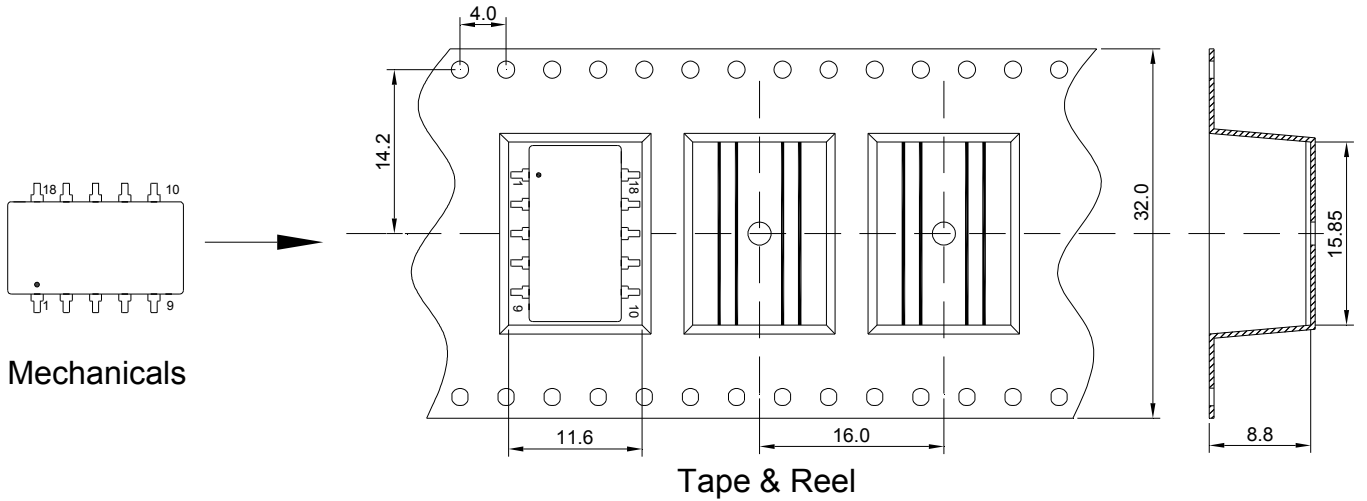

Packing Information:

Weight-----1.36grams/pcs

TUBE-----33pcs

Weight: 65g per tube

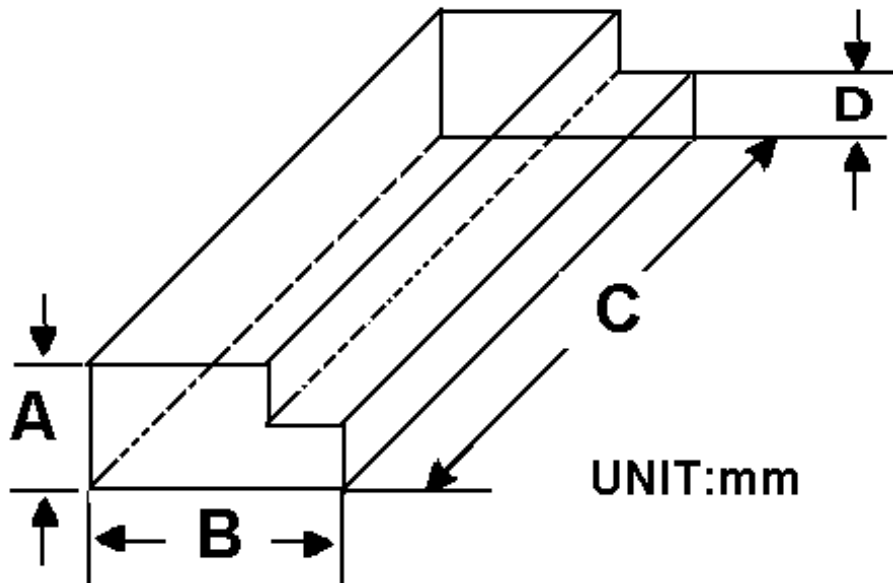

Size(mm)			
A	B	C	D
9.50	16.50	522	5.00

Outer carton unit: 3300pcs/100Tube/box

Weight: 7.5kg per carton

