

## Features

- 1WATT SMD PACKAGE
- EFFICIENCY TO 82%
- 100% BURNED IN
- UL 94V-0 PACKAGE MATERIAL
- CUSTOM SOLUTIONS AVAILABLE
- UNREGULATED OUTPUT TYPES



**1 Watt DC/DC Converter**

1 Watt Single O/P  
Isolated DC-DC Converter <sup>®</sup>

## Input Specifications

Input Voltage	:12Vdc
Input Voltage Range	:±20%

## Output Specifications

Output Voltage	:5Vdc	
Output Voltage Accuracy	:±5%	@Vout=4.75-5.25Vdc@Vin=12Vdc
Output Current	:200mA	
Efficiency	:82% TYP	
Ripple / Noise	: 30mVp-p TYP, 75mVp-p MAX	@20MHz Bandwidth
Short Circuit Protection	:Continuous	
Line Regulation	:±1.2% TYP	@ For 1.0% OF Vin
Load Regulation	:±15% MAX	@10% to 100% full load

## General Specifications

Operating Temperature Range	: -40°C ~ +105°C	
Storage Temperature	: -55°C ~ +125°C	
Switching Frequency	: 250KHz TYP	
Humidity	: 95% MAX	
Isolation Voltage	: 1500Vdc	@ Input to Output ( 60sec/0.5mA )
Isolation Resistance	: 1000MΩ MIN	@ 500Vdc
Cooling	: Free air convection	
MTBF	: >3500000 Hours	MIL-HDBK-217F@25°C, Ground Benign.
Case Material	: DAP	
Weight	: 1.2g TYP	
EMI	CE	CISPR32/EN55032 CLASS B (see Fig. 1 for recommended circuit)
	RE	CISPR32/EN55032 CLASS B (see Fig. 1 for recommended circuit)
EMS	ESD	IEC/EN61000-4-2 Air ±8kV , Contact ±4kV perf. Criteria B

## Temperature Derating Graph

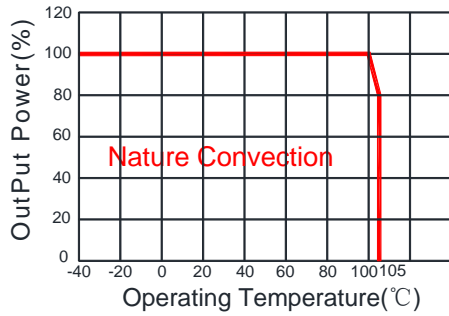

## Part Number

13DSC - 12 S 05 N P  
A B C D E F

A:Series  
B:Input Voltage  
C:Single Output  
D:Output Voltage  
E:Unregulated(N)  
F:Protection

## Recommended Test Circuit

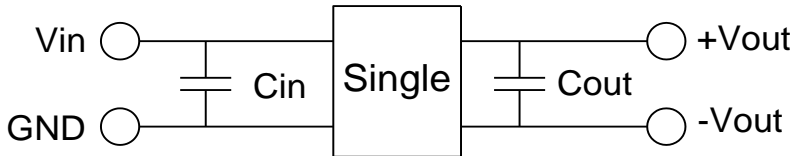

Vin	Cin	SingleVout	Cout
12Vdc	2.2μF/25V	5Vdc	10μF/16V

To make sure the product work at perfect operation status with full loading external capacitor is necessary and it is recommended to use high frequency low resistance electrolytic capacitor.

## EMC (CLASS B) compliance circuit

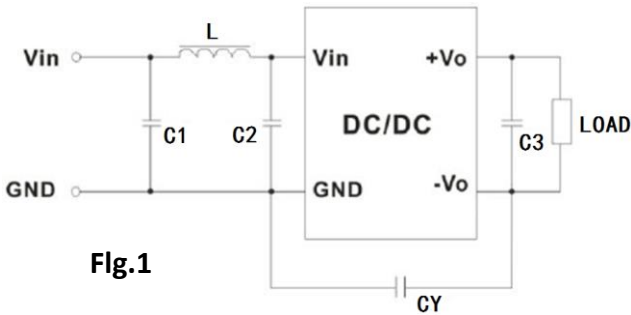
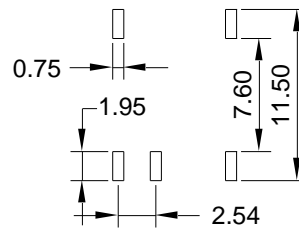
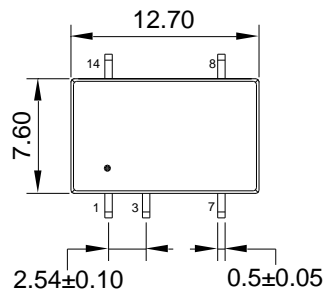

Fig.1

EMC recommended circuit value table

EMI	C1	4.7μF /50V
	C2	4.7μF /50V
	CY	1nF/4kV
	C3	Recommended Test Circuit
	L	6.8μH

## Outline Dimensions



SUGGESTED PAD LAYOUT

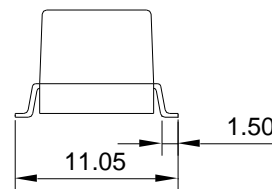
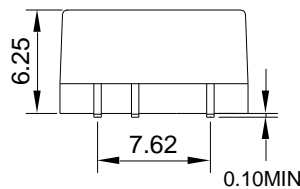

UNIT : mm Unless otherwise specified, all tolerances are ±0.25

PIN	1	3	7	8	14
Single	-Vin	+Vin	-Vout	+Vout	NC

## RoHS compliant type

Our RoHS parts just can withstand IR Reflow peak temperature: 240degC +/-5degC as the following profile:

Profile Feature	Pb-Free Assembly
Average Ramp-Up Rate ( $T_{s_{max}}$ to $T_p$ )	3°C /second max.
Preheat -Temperature Min ( $T_{s_{min}}$ ) -Temperature Max ( $T_{s_{max}}$ ) -Time ( $t_{s_{min}}$ to $t_{s_{max}}$ )	150°C 200°C 60-180 seconds
<b>Time maintained above:</b> -Temperature ( $T_L$ ) -Time ( $t_L$ )	217°C 60-150 seconds
Peak/Classification Temperature ( $T_p$ )	240±5 °C
Time within 5°C of actual Peak Temperature ( $t_p$ )	20-40 seconds
Ramp-Down Rate	6°C/seconds max
Time 25°C to Peak Temperature	6 minutes max.



**Packing Information:**

1. Weight-----1.2 grams/pcs
2. Tape & Reel----- 350 pcs
3. outer carton unit: 3500pcs/box
4. outer carton unit: 10T&R/box
5. Weight: 9.5kg per carton

