

Features

- 1WATT SIP PACKAGE
- EFFICIENCY TO 85%
- 100% BURNED IN
- UL 94V-0 PACKAGE MATERIAL
- CUSTOM SOLUTIONS AVAILABLE
- UNREGULATED OUTPUT TYPES



**1 Watt DC/DC
Converter**

1 Watt Dual O/P
Isolated DC-DC Converter [®]

Input Specifications

| | |
|---------------------|--------|
| Input Voltage | :12Vdc |
| Input Voltage Range | :±20% |

Output Specifications

| | | |
|--------------------------|---------------------------|--------------------------------|
| Output Voltage | :±12Vdc | |
| Output Voltage Accuracy | :±5% | @Vout=±11.4~±12.6Vdc@Vin=12Vdc |
| Output Current | :±42mA | |
| Efficiency | :85% TYP | |
| Ripple / Noise | :30mVp-p TYP, 75mVp-p MAX | @20MHz Bandwidth |
| Short Circuit Protection | : Continuous | |
| Line Regulation | :±1.2% TYP | @For 1.0% OF Vin |
| Load Regulation | :±8% TYP, ±10% MAX | @10% to 100% full load |
| Capacitive Load | :±330uF MAX | |

General Specifications

| | | |
|-----------------------------|-----------------------|--|
| Operating Temperature Range | : -40°C ~ +105°C | |
| Storage Temperature | : -55°C ~ +125°C | |
| Switching Frequency | : 250KHz TYP | |
| Humidity | : 95% MAX | |
| Isolation Voltage | : 1500Vdc | @ Input to Output (60sec/0.5mA) |
| Isolation Resistance | : 1000MΩ MIN | @ 500Vdc |
| Cooling | : Free air convection | |
| MTBF | : >3500000 Hours | MIL-HDBK-217F@25°C, Ground Benign. |
| Case Material | : DAP | |
| Weight | : 2.1g TYP | |
| EMI | CE | CISPR32/EN55032 CLASS B (see Fig. 1 for recommended circuit) |
| | RE | CISPR32/EN55032 CLASS B (see Fig. 1 for recommended circuit) |
| EMS | ESD | IEC/EN61000-4-2 Air ±8kV , Contact ±4kV perf. Criteria B |

Temperature Derating Graph

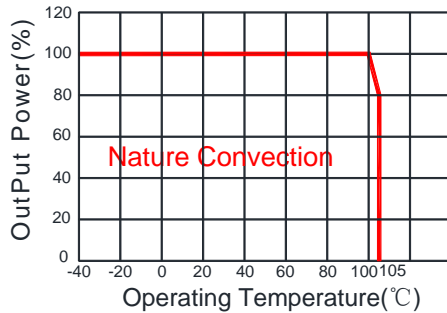

Part Number

14DC - 12 D 12 N P
A B C D E F

A:Series
B:Input Voltage
C: Dual Output
D: Output Voltage
E: Unregulated(N)
F: Protection

Recommended Test Circuit

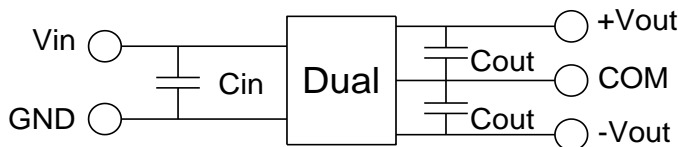

| Vin | Cin | Dual Vout | Cout |
|-------|-----------|-----------|----------|
| 12Vdc | 2.2μF/25V | ±12Vdc | ±1μF/16V |

To make sure the product work at perfect operation status with full loading external capacitor is necessary and it is recommended to use high frequency low resistance electrolytic capacitor.

EMC (CLASS B) compliance circuit

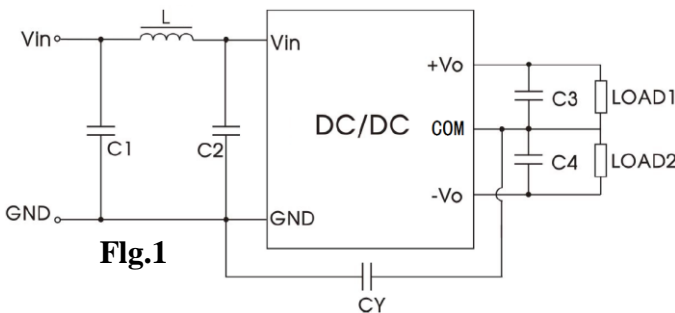

| EMC recommended circuit value table | | |
|-------------------------------------|----|--------------------------|
| EMI | C1 | 4.7μF /50V |
| | C2 | 4.7μF /50V |
| | CY | 1nF/4kV |
| | C3 | Recommended Test Circuit |
| | L | 6.8μH |

Outline Dimensions

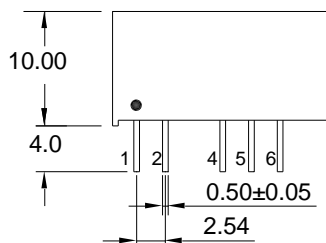
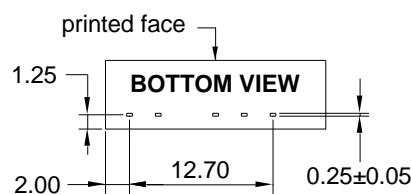
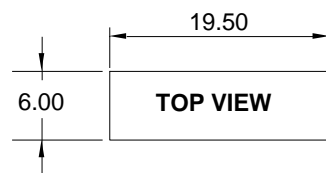

UNIT:mm Unless otherwise specified,all tolerances are ±0.25

| PIN | 1 | 2 | 4 | 5 | 6 |
|------|------|------|-------|-----|-------|
| DUAL | +Vin | -Vin | -Vout | COM | +Vout |

Packing Information:

Weight----- 2.1grams/pcs

TUBE-----25pcs

Weight: 73g per tube

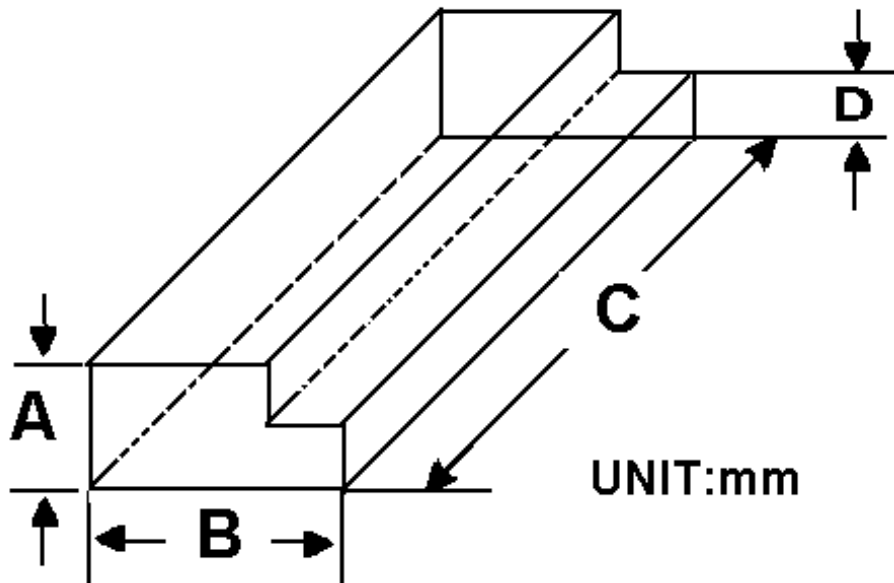

| Size(mm) | | | |
|----------|-------|-----|------|
| A | B | C | D |
| 9.50 | 16.50 | 522 | 5.00 |

Outer carton unit: 2500pcs/100Tube/box

Weight: 7.5kg per carton

