

Features

- 9 WATT SIP PACKAGE
- 4:1 WIDE INPUT VOLTAGE
- EFFICIENCY TO 86%
- 100% BURNED IN
- INTERNAL SMD CONSTRUCTION
- CUSTOMIZED SOLUTIONS AVAILABLE
- REGULATED OUTPUT TYPE



**9 Watt DC/DC
Converter**

WIDE INPUT VOLTAGE RANGE
9 WATT DC-DC CONVERTER

Input Specifications

Input Voltage	:24Vdc	
Input Voltage Range	:9~36Vdc	
Remote ON/OFF	:Open or 0~1V (DC/DC ON) :2.2~12V(DC/DC OFF)	@ Refer to -Vin PIN
	:-0.5 ~ +0.5 mA	@Input current of Remote ON/OFF pin
	:5 mA TYP	@Remote off input current

Output Specifications

Output Voltage	:±5Vdc	
Output Voltage Accuracy	:±2%	@±4.9~±5.1Vdc @Vin=9~36Vdc
Output Current	:±800mA	
Efficiency	:86% TYP	@Vin=24Vdc
Ripple / Noise	:100mVp-p MAX	@20MHz Bandwidth
Short Circuit Protection	:Continuous	@Auto-recovery
Line Regulation	:±0.5% MAX	@Full Load
Load Regulation	:±1.0% MAX	@25% to 100% Load

General Specifications

Operating Temperature Range	:-40°C ~ +75°C (with derating)	
Storage Temperature	:-55°C ~ +125°C	
Switching Frequency	:500KHz TYP	
Humidity	:95% MAX	
Isolation Voltage	:1600Vdc	@Input to Output
Isolation Resistance	:1000MΩ MIN	@500Vdc
Cooling	:Natural Convection	@20LFM
MTBF	:2696000 Hours	MIL-HDBK-217F@25°C,Ground Benign.
Case Material	:Plastic	
Weight	:4.8g TYP	

Temperature Derating Graph

Part Number

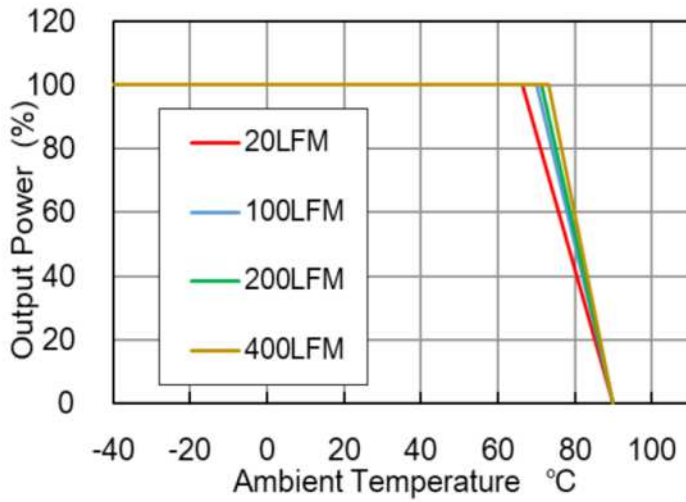

27DW- 24 D 05 R 9W
A B C D E F

- A: Series**
- B: Input Voltage**
- C: Single Output**
- D: Output Voltage**
- E: Regulated(R)**
- F: Output Power**

Outline Dimensions

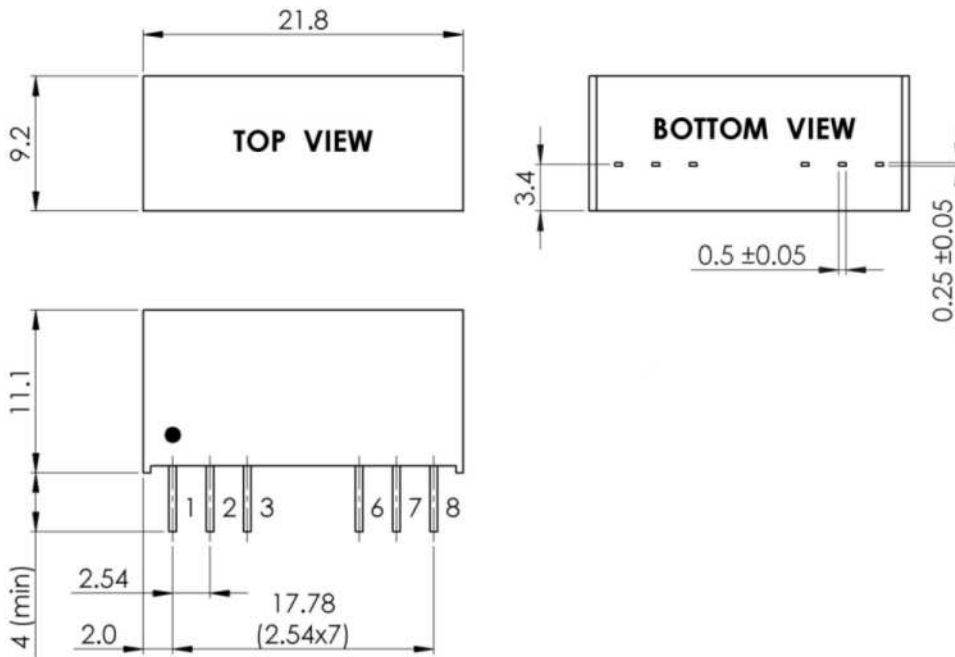

Unit : mm
 Tolerance : XX.X \pm 0.5 , XX.XX \pm 0.25

PIN Assignment

PIN	1	2	3	6	7	8
FUNCTION	-Vin	+Vin	Remote ON/OFF	+Vout	Com	-Vout

Packing Formation

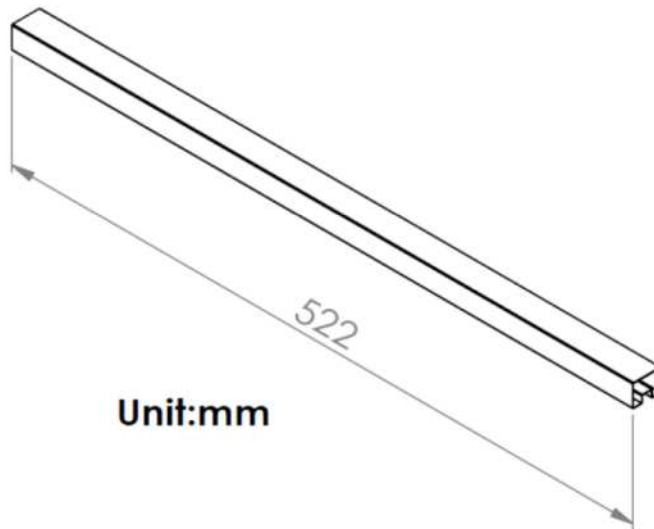
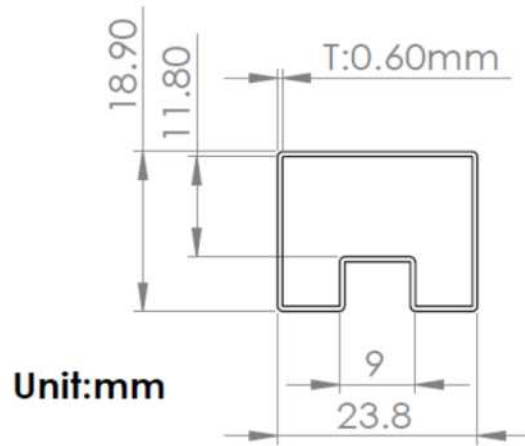

Weight	: 4.8 grams/pcs
Tube	: 44 pcs