

Features

- 15 WATT DIL PACKAGE
- EFFICIENCY TO 87%
- PI INPUT FILTER
- 100% BURNED IN
- UL 94V-0 PACKAGE MATERIAL
- CUSTOMIZED SOLUTIONS AVAILABLE
- REGULATED OUTPUT TYPE
- Remote Control: On/Off



**15 Watt DC/DC
Converter**

WIDE INPUT VOLTAGE RANGE

15 WATT DC-DC CONVERTER

Input Specifications

Input Voltage	:24Vdc	
Input Voltage Range	:9~36Vdc	
Under voltage shut down (lock-out circuit)	:8.0 Vdc Typ	
Remote ON/OFF	:Open or 3~12Vdc(DC/DC ON)	@Positive logic
	:Short or 0~1.2Vdc(DC/DC OFF)	(Refer to -Vin PIN)
	: -0.5 ~ +0.5 mA	@Input current of Remote ON/OFF pin
	:3 mA TYP	@Remote off input current

Output Specifications

Output Voltage	:5Vdc	
Output Voltage Accuracy	:±2%	@4.9~5.1Vdc @Vin=9~36Vdc
Output Current	:3000mA	
Efficiency	:87% TYP	@Vin=24Vdc
Ripple / Noise	:100mVp-p MAX	@20MHz Bandwidth
Short Circuit Protection	:Continuous	@Hiccup, auto-recovery
Line Regulation	:±0.5% MAX	@ Full Load
Load Regulation	:±0.5% MAX	@25% TO 100% Load

General Specifications

Operating Temperature Range	: -40°C ~ +82°C (with derating)	Output load derate 2.86% per degree Celsius above 65°C as refer to temperature derating graph.
Storage Temperature	: -55°C ~ +125°C	
Switching Frequency	: 400KHz TYP	
Humidity	: 95% MAX	
Isolation Voltage	: 1500Vdc	
Isolation Resistance	: 1000MΩ MIN	
Cooling	: Natural Convection	@20LFM
MTBF	: >=560000 Hours	MIL-HDBK-217F@25°C, Ground Benign.
Case Material	: Six-side shielded case	
Weight	: 16.5g TYP	

Temperature Derating Graph

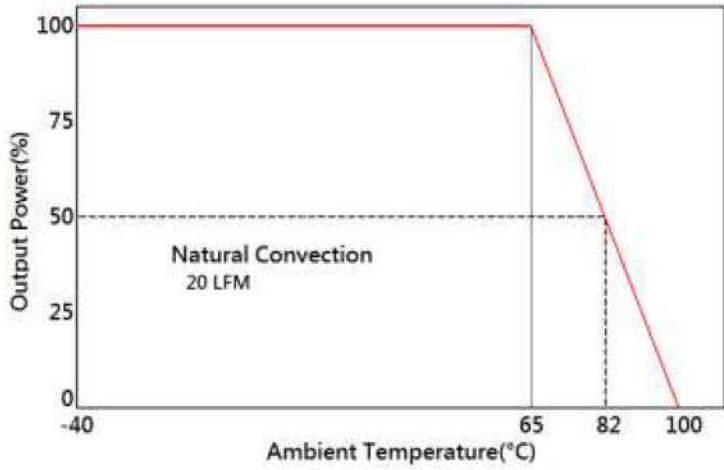

Part Number

68DW15- 24 S 05 R NL
A B C D E F

- A: Series**
- B: Input Voltage**
- C: Single Output**
- D: Output Voltage**
- E: Regulated(R)**
- F: RoHs Version**

Outline Dimensions

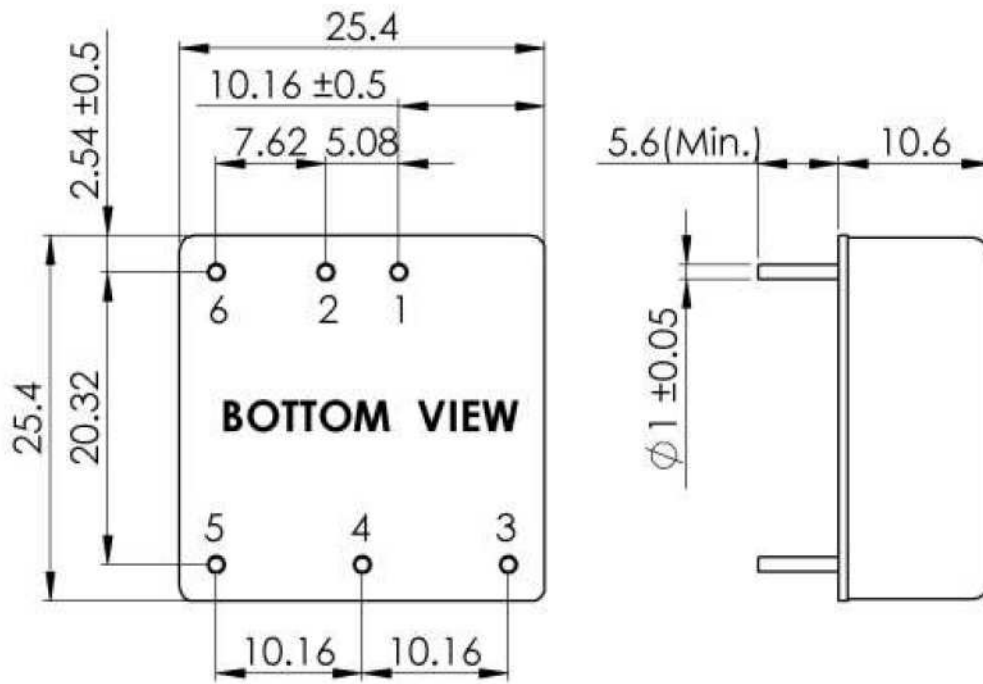

Unit : mm
Tolerance : XX.X ± 0.5 , XX.XX ± 0.25

PIN Assignment

PIN	1	2	3	4	5	6
FUNCTION	+Vin	-Vin	+Vout	Trim	-Vout	Remote On/Off

Packing Formation

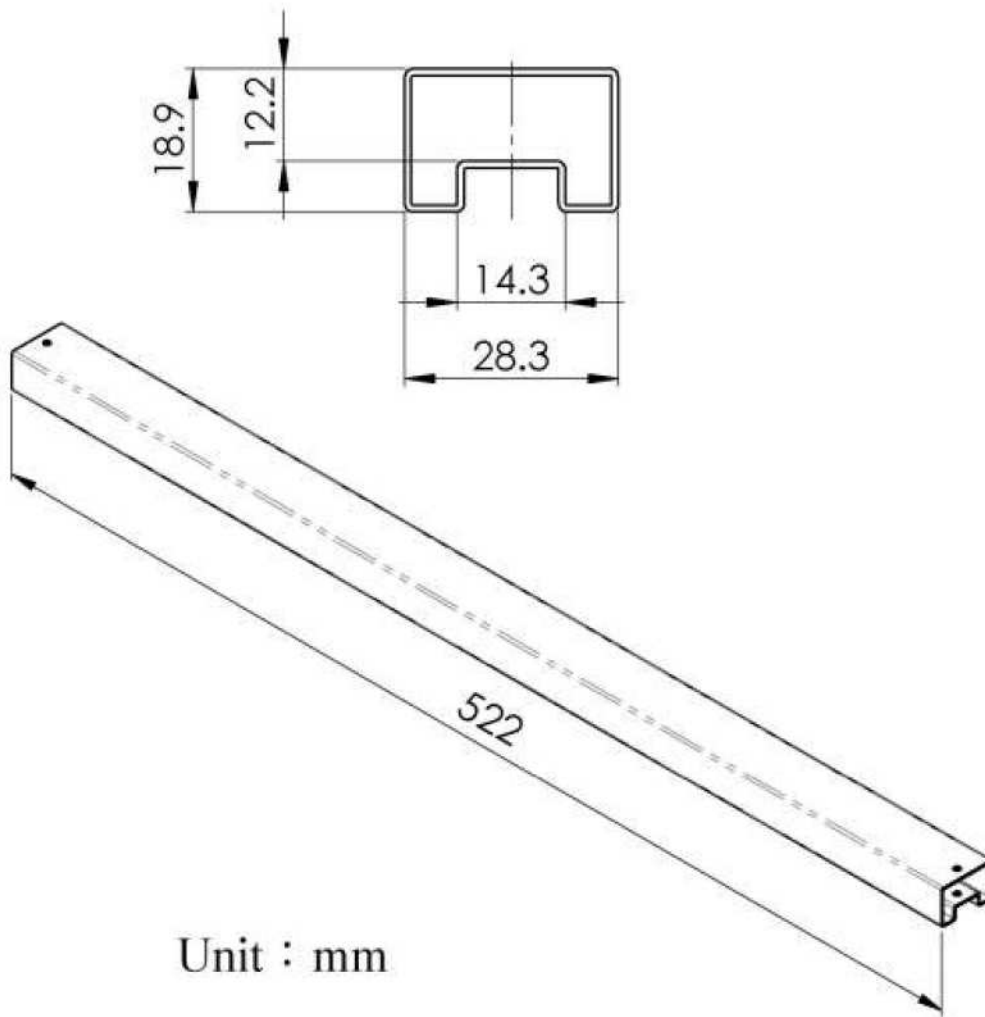

Unit : mm

Weight	: 16.5 grams/pcs
TUBE	: 19 pcs