

Features

- 15W DIL Package
- 4:1 WIDE INPUT VOLTAGE
- EFFICIENCY TO 89%
- 100% BURNED IN
- UL 94V-0 PACKAGE MATERIAL
- CUSTOMIZED SOLUTIONS AVAILABLE



15 Watt DC/DC Converter

WIDE INPUT VOLTAGE RANGE
15 WATT DC-DC CONVERTER



Input Specifications

Input Voltage	:24Vdc
Input Voltage Range	:9~36Vdc

Output Specifications

Output Voltage	:5Vdc	
Output Voltage Accuracy	:±2%	@4.9~5.1Vdc @Vin=9~36Vdc
Output Current	:3000mA	
Efficiency	:89% TYP	@Vin=24Vdc, 100% load
Ripple / Noise	:100mVp-p MAX	@20MHz Bandwidth
Short Circuit Protection	:Continuous	@Hiccup, auto-recovery
Line Regulation	:±0.5% MAX	@Full Load
Load Regulation	:±0.5% MAX	@0% TO 100% load

General Specifications

Operating Temperature Range	: -40°C ~ +59.2°C	without derating @ Nominal Vin
Storage Temperature	: -55°C ~ +125°C	
Switching Frequency	:270KHz TYP	
Humidity	:95% MAX	
Isolation Voltage	:1600Vdc	
Isolation Resistance	:1000M Ω MIN	
Cooling	:Natural Convection	@20LFM
MTBF	:705000 Hours	MIL-HDBK-217F@25°C (calculated)
Case Material	:Copper	
Weight	:11g TYP	

Temperature Derating Graph

Part Number

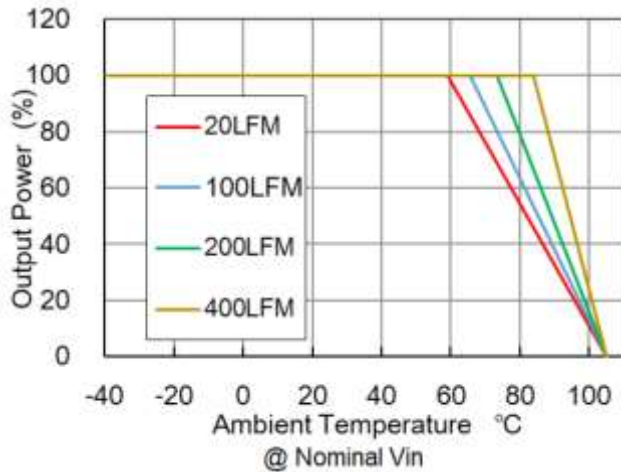

YTB **15** - **24** **S** **05**
A **B** **C** **D** **E**

- A: Series**
- B: Output Power**
- C: Input Voltage**
- D: Single Output**
- E: Output Voltage**

Outline Dimensions

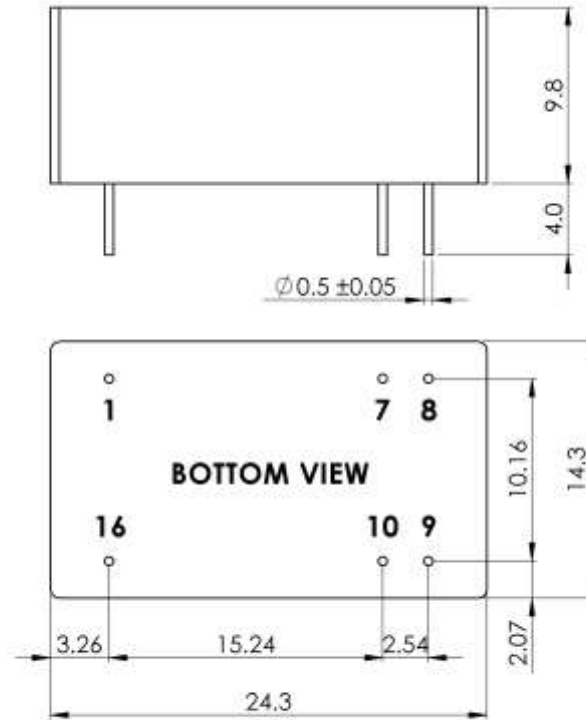

Unit : mm
 Tolerance : XX.X ± 0.5 , XX.XX ± 0.25

PIN Assignment

PIN	1	7	8	9	10	16
FUNCTION	-Vin	NC	NC	+ Vout	-Vout	+Vin

Packing Formation

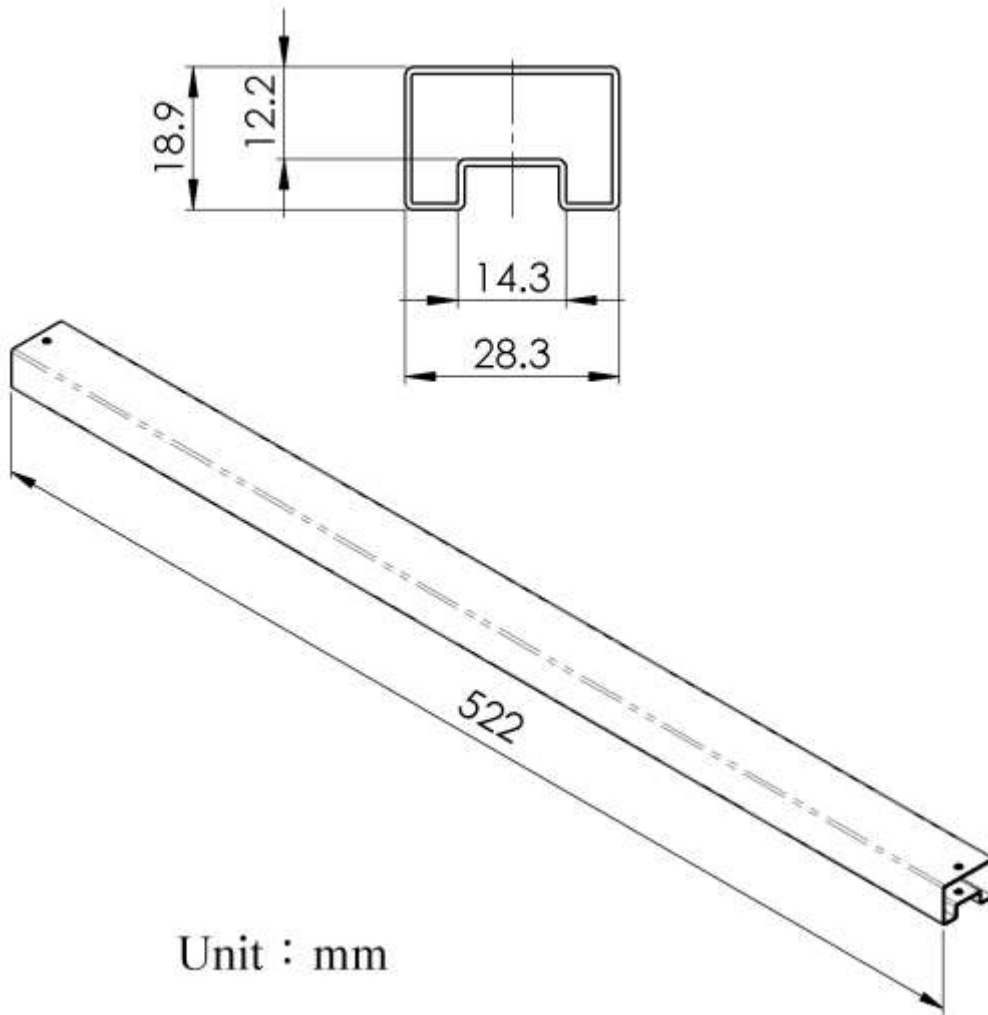

Weight	: 11 grams/pcs
TUBE	: 35 pcs