

**Features**

- 15W DIL Package
- 4:1 WIDE INPUT VOLTAGE
- EFFICIENCY TO 89%
- 100% BURNED IN
- UL 94V-0 PACKAGE MATERIAL
- CUSTOMIZED SOLUTIONS AVAILABLE



15 Watt DC/DC Converter

WIDE INPUT VOLTAGE RANGE  
15 WATT DC-DC CONVERTER



**Input Specifications**

Input Voltage	:24Vdc
Input Voltage Range	:9~36Vdc

**Output Specifications**

Output Voltage	:24Vdc	
Output Voltage Accuracy	:±2%	@23.52~24.48Vdc @Vin=9~36Vdc
Output Current	:625mA	
Efficiency	:89% TYP	@Vin=24Vdc, 100% load
Ripple / Noise	:100mVp-p MAX	@20MHz Bandwidth
Short Circuit Protection	:Continuous	@Hiccup, auto-recovery
Line Regulation	:±0.5% MAX	@Full Load
Load Regulation	:±0.5% MAX	@0% TO 100% load

**General Specifications**

Operating Temperature Range	: -40°C ~ +59.2°C	without derating @ Nominal Vin
Storage Temperature	: -55°C ~ +125°C	
Switching Frequency	:390KHz TYP	
Humidity	:95% MAX	
Isolation Voltage	:1600Vdc	
Isolation Resistance	:1000M Ω MIN	
Cooling	:Natural Convection	@20LFM
MTBF	:705000 Hours	MIL-HDBK-217F@25°C (calculated)
Case Material	:Copper	
Weight	:11g TYP	

Temperature Derating Graph

Part Number

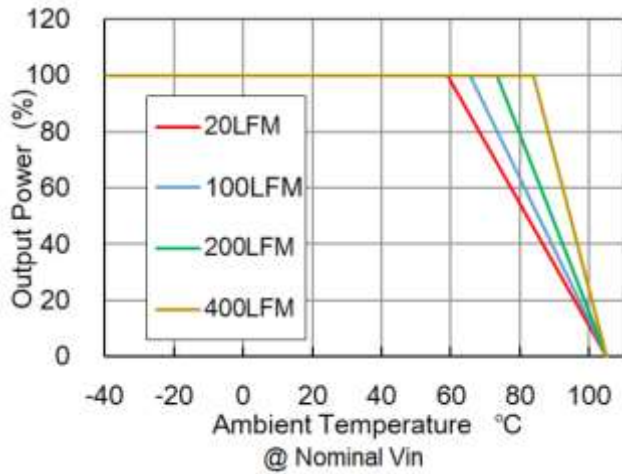

**YTB** **15** - **24** **S** **24**  
**A** **B** **C** **D** **E**

- A: Series**
- B: Output Power**
- C: Input Voltage**
- D: Single Output**
- E: Output Voltage**

Outline Dimensions

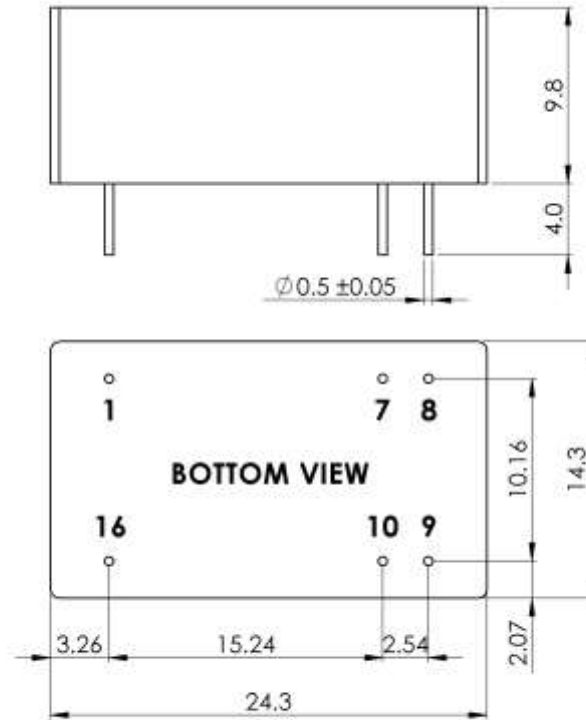

Unit : mm  
 Tolerance : XX.X ± 0.5 , XX.XX ± 0.25

PIN Assignment

PIN	1	7	8	9	10	16
FUNCTION	-Vin	NC	NC	+ Vout	-Vout	+Vin

**Packing Formation**

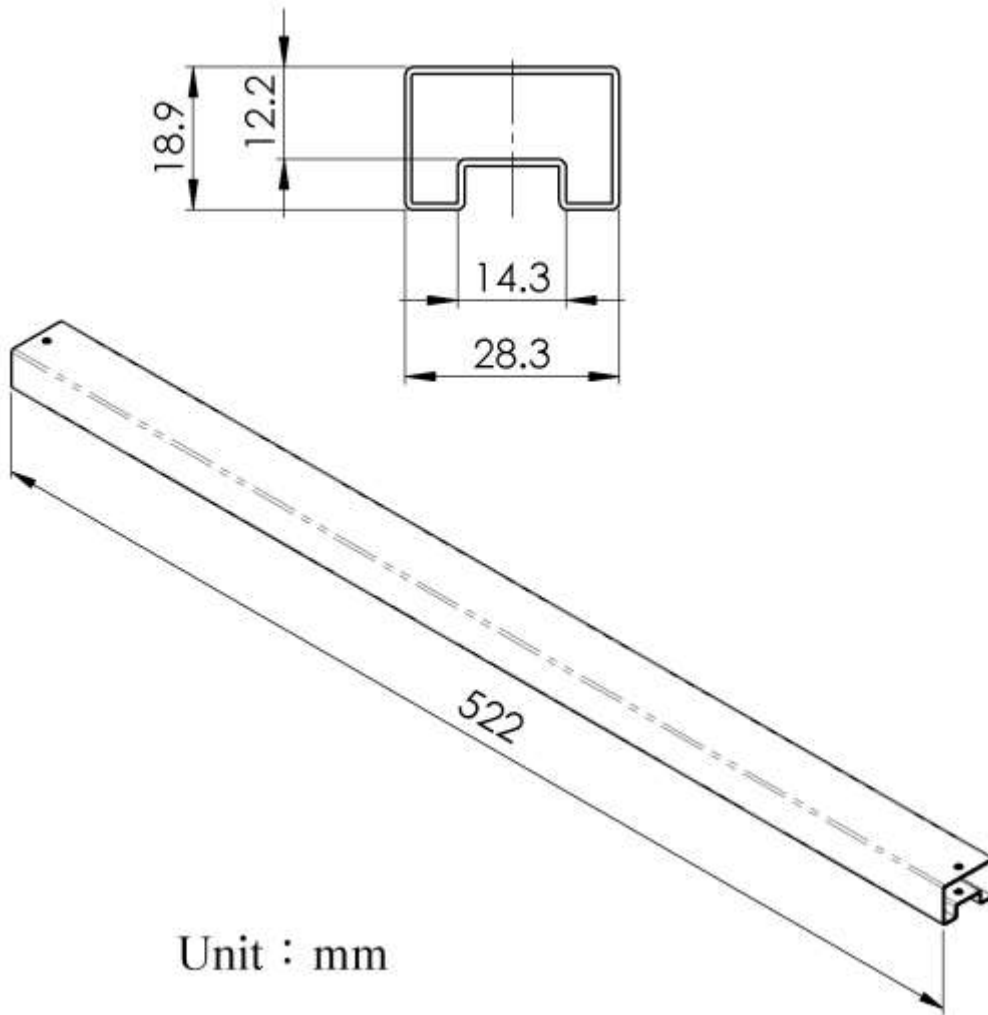

<b>Weight</b>	<b>: 11 grams/pcs</b>
<b>TUBE</b>	<b>: 35 pcs</b>